

EFFECTS OF FOREST FIRES  
ON  
TIMBER HARVEST LEVELS

by

Vivienne M. Ball R.P.F. ©

A Graduate Thesis Submitted  
In Partial Fulfillment of the Requirements  
for the Degree of Master of Science in Forestry

School of Forestry  
Lakehead University

November, 1994

ProQuest Number: 10611876

All rights reserved

INFORMATION TO ALL USERS

The quality of this reproduction is dependent upon the quality of the copy submitted.

In the unlikely event that the author did not send a complete manuscript and there are missing pages, these will be noted. Also, if material had to be removed, a note will indicate the deletion.



ProQuest 10611876

Published by ProQuest LLC (2017). Copyright of the Dissertation is held by the Author.

All rights reserved.

This work is protected against unauthorized copying under Title 17, United States Code  
Microform Edition © ProQuest LLC.

ProQuest LLC.  
789 East Eisenhower Parkway  
P.O. Box 1346  
Ann Arbor, MI 48106 - 1346



National Library  
of Canada

Acquisitions and  
Bibliographic Services Branch

395 Wellington Street  
Ottawa, Ontario  
K1A 0N4

Bibliothèque nationale  
du Canada

Direction des acquisitions et  
des services bibliographiques

395, rue Wellington  
Ottawa (Ontario)  
K1A 0N4

*Your file* *Votre référence*

*Our file* *Notre référence*

**The author has granted an irrevocable non-exclusive licence allowing the National Library of Canada to reproduce, loan, distribute or sell copies of his/her thesis by any means and in any form or format, making this thesis available to interested persons.**

**L'auteur a accordé une licence irrévocable et non exclusive permettant à la Bibliothèque nationale du Canada de reproduire, prêter, distribuer ou vendre des copies de sa thèse de quelque manière et sous quelque forme que ce soit pour mettre des exemplaires de cette thèse à la disposition des personnes intéressées.**

**The author retains ownership of the copyright in his/her thesis. Neither the thesis nor substantial extracts from it may be printed or otherwise reproduced without his/her permission.**

**L'auteur conserve la propriété du droit d'auteur qui protège sa thèse. Ni la thèse ni des extraits substantiels de celle-ci ne doivent être imprimés ou autrement reproduits sans son autorisation.**

ISBN 0-612-09192-9

**Canada**

ABSTRACT

Ball, V.M. 1994. Effects of Forest Fires on Timber Harvest Levels. 136 pp. Major Advisor: Dr. K.M. Brown.

Key Words: timber management planning, forest fire, forest regulation

Traditional approaches to timber management planning do not address the realities of catastrophic wildfire. The model FORMAN is one of the operational wood supply models used in Ontario for forest regulation. The FORTRAN program FORMANB.FOR, presented here, incorporates the subprogram BURN.FOR, that models continuous wildfire according to historical patterns. Incorporating the risk of forest fire on the Nakina Forest lowered the sustainable harvest level from 520,000 m<sup>3</sup>/year to 473,500 m<sup>3</sup>/year (9%).

When choosing the sustainable harvest level in light of this, the forest manager must evaluate options within a larger timber supply context. The ability to consider risk of fire explicitly as part a wood supply analysis should increase the forest manager's confidence in long-term timber supply projections and short-term harvest levels.

## TABLE OF CONTENTS

	Page
ABSTRACT .....	ii
LIST OF TABLES .....	v
LIST OF FIGURES .....	vi
CHAPTER I. INTRODUCTION .....	1
CHAPTER II. LITERATURE REVIEW .....	3
A CONTEXT FOR DECISION MAKING .....	3
MODELLING SYSTEMS .....	4
TIMBER MANAGEMENT SYSTEMS .....	6
FOREST FIRE RESEARCH IN FORESTRY .....	13
Forest Fire Behaviour .....	13
Stand-Level Research .....	14
Forest-Level Research .....	16
CHAPTER III. FORMAN AS AN OPERATIONAL PLANNING TOOL .....	22
EVALUATION OF THE MODEL .....	25
MODIFICATIONS OF FORMAN .....	28
KIMBERLY CLARK APPLICATION .....	29
CHAPTER IV. THE BURN SUBPROGRAM .....	31
CHAPTER V. EFFECT OF FIRE ON SUSTAINABLE HARVEST LEVELS .....	41
FOREST DESCRIPTION .....	41
HARVEST SCHEDULING IN ABSENSE OF FIRE .....	42
Sustainable Harvest Level .....	44
HARVEST SCHEDULING WITH RISK OF FIRE .....	46
CHAPTER VI. RESULTS AND DISCUSSION .....	60
OPTION EVALUATION .....	63
Wood Supply Analysis .....	64
Evaluating Option 1 .....	66
Evaluating Option 2 .....	70

Evaluating Option 3 .....	72
FUTURE CONSTRAINTS VS PRESENT REALITIES ....	72
LIMITATION OF FIRE DATA .....	73
FORESTRY INVESTMENT .....	74
FURTHER RESEARCH AND APPLICATIONS .....	74
REFERENCES .....	76
APPENDICES .....	80
APPENDIX A .....	81
APPENDIX A-1    Call Statement in FORMANB to invoke subroutine BURN .....	82
APPENDIX A-2    Subprogram BURN.FOR .....	84
APPENDIX A-3    Subprogram SETUP.FOR .....	88
APPENDIX A-4    Subprogram NOSTART.FOR .....	90
APPENDIX A-5    Subprogram AREA.FOR .....	92
APPENDIX A-6    Subprogram MONTE.FOR .....	94
APPENDIX A-7    Subprogram RAN.FOR .....	97
APPENDIX A-8    Subprogram ASSIGN.FOR .....	99
APPENDIX A-9    Subprogram FLAM.FOR .....	104
APPENDIX A-10   Subprogram LOSS.FOR .....	106
APPENDIX B .....	110
APPENDIX B-1    Age class distribution of white birch on the Nakina Forest .....	111
APPENDIX B-2    Age class distribution of poplar on the Nakina Forest .	113
APPENDIX B-3    Age class distribution of jack pine on the Nakina Forest .....	115
APPENDIX B-4    Age class distribution of balsam fir on the Nakina Forest .....	117
APPENDIX B-5    Age class distribution of spruce site class X,1,2 (upland) on the Nakina Forest .....	119
APPENDIX B-6    Age class distribution of spruce site class X,1,2 (lowland) on the Nakina Forest .....	121
APPENDIX B-7    Age class distribution of site class 3, PFR on the Nakina Forest .....	123
APPENDIX B-8    Forest class file (grostk.nak) for the Nakina Forest .....	125

APPENDIX B-9	Curve set file (yield.viv) for the Nakina Forest .....	129
APPENDIX B-10	Treatment cost file (Silvcost) for the Nakina Forest .....	132
APPENDIX B-11	FORMAN short report for the Nakina Forest .....	134

## LIST OF TABLES

	Page
Table 1. A sample of output from subroutine LOSS.FOR. The body of the table contains summary statistics for 14 simulated fires that occurred during a single 5-year interval (years 20 to 25) within simulation run 7 ..	39
Table 2. A sample of output from subroutine BURN.FOR. The body of the table contains summary statistics for 312 fires that occurred during the 100 years of simulation run 7 ..	40
Table 3. Input Parameters for FORMAN simulations for the Nakina Forest.....	43
Table 4. Historical Forest Fire Statistics - Geraldton District (1957-1989) .....	47
Table 5. Sustainable harvest levels from twenty (20) simulation runs with FORMANB.FOR. ....	50
Table 6. Summary of BURN statistics for twenty (20) 100-year simulation runs .....	52
Table 7. Summary of FORMANB short reports, ranked by burn area, for twenty (20) 100-year simulation runs. ....	53
Table 8. Summary of FORMANB short reports, ranked by primary volume varvested for twenty (20) 100-year simulation runs. ....	54
Table 9. Summary of FORMANB short reports, ranked by primary volume lost for twenty (20) 100-year simulation runs. ....	55
Table 10. Comparison of burn area and growing stock, ranked by burn area for twenty (20) 100-year simulation runs. ....	56



## LIST OF FIGURES

	Page
Figure 1. Flowchart of the FORMAN process .....	26
Figure 2. Flowchart of the BURN algorithm .....	32
Figure 3. Schematic Diagram of BURN.FOR and Link to FORMAN .....	34
Figure 4. Burn area vs number of fires from 30 years of historical forest fire statistics from Geraldton district (1957-1988) .....	48
Figure 5. A rank-order listing of the maximum sustainable harvest levels obtained from twenty (20) 100-year simulation runs of FORMANB.FOR ...	51
Figure 6. Total growing stock at year 100 vs burn area for twenty (20) 100-year simulation runs. ....	57
Figure 7. Total growing stock at year 100 vs sustainable harvest level for twenty (20) 100-year simulation runs. ....	59

## CHAPTER I. INTRODUCTION

Some timber management decisions are routinely made without complete knowledge of risk or uncertainty. Some forest managers prefer to ignore phenomena that cannot be explained. The hesitancy to deal with the unknown has impeded the use of risk management techniques in solving forest management problems (Dempster and Stevens, 1987). Forest managers have not had to face the uncertainty of timber losses by wildfire because the forest resource has been perceived to be unlimited.

One of the most frequent decisions made in timber management planning is how much to harvest. There are a variety of approaches that have been used to assist in this decision. They attempt to quantify, given the structure of the forest, how much to be harvested now, and into the future. In Ontario the harvest level is revisited every five years through the timber management planning process. Over the years, methods have progressed from straightforward mathematical formulae to sophisticated computer models.

Traditional methods of harvest level determination do not explicitly account for potential losses from forest fire. Instead, losses are anticipated using contingency

planning. Some timber management plans include large buffer inventories of timber as an insurance policy against potential large losses.

When wood supply levels are tight, any timber loss is critical. The importance of forest fire in the Boreal Forest make it possible that catastrophic disaster may occur in the future. Foresters have little knowledge of when, where, or to what extent these fires may occur.

My purpose is to incorporate the risk of continuous wildfire, i.e. varying amounts and intensities of fire, into an operational wood supply model, FORMAN (Wang et al., 1987), and explore the possible implications on decision making, specifically on harvest level determination. The central question I wish to address is: are the current risk management strategies adequate to deal with risk of fire when determining sustainable harvest levels? To explore this question I have modified the FORMAN model by incorporating a subprogram that simulates fire occurrence. The Nakina Forest, managed by Kimberly Clark (KC) of Longlac and the Ontario Ministry of Natural Resources (OMNR), is used as a case study.

## CHAPTER II. LITERATURE REVIEW

## A CONTEXT FOR DECISION MAKING

Decisions are made under one of three sets of conditions: certainty, risk and uncertainty (Thompson, 1968). Under a state of certainty an alternative is chosen, and only one outcome is possible. For example, if a decision is made to withdraw forested land from a sawmill's traditional wood supply basin, it is certain that there will be a reduction in volume available to harvest from that area.

If a decision can yield more than one outcome and the probability of each outcome is known, then the decision is being made under a condition of risk. Consider the decision to delay the harvest of a forest stand beyond rotation age. Dempster and Stevens (1987) determined the probability of the stand surviving beyond rotation age to design a risk-adjusted harvest schedule.

If several outcomes are possible, but the probability of each is unknown, then the decision is being made under a condition of uncertainty. Consider a decision to retain old growth trees in hardwood stands for forest biodiversity objectives. Several impacts could be possible for the

sawmill industry dependant on old growth. They may close mills, they may seriously affect others, while they may not affect the remaining mills. The probabilities associated with each are unknown.

## MODELLING SYSTEMS

A system is a connected set of parts that contribute to a whole (Morton, 1990). In a system each element interacts with the other elements to perform some function (Kleijnen, 1974). Inputs from the system's environment are transformed by the system's internal mechanisms into outputs.

Systems can be either static or dynamic. A dynamic system changes over time. Feedback mechanisms inherent in the system are constantly reacting to changes detected either internally or externally. The system adapts to these changes and evolves over time. A static system does not change over time.

In a deterministic system the relationships between the elements are constant over time (Rubinstein, 1981). In a stochastic system the behaviour of one or more elements is random.

Duinker (1994) described forest management as a system. Harvest, regeneration and road access are activities that take place in the forest as inputs to the

system. The state of the system at any point in time describes the structure of the system. Age-class structure or wildlife carrying capacity are state descriptors. The benefits derived from the forest such as wood fibre or recreational experience are system outputs.

To understand a system, analysts define the components that make up the system, the nature of the interactions among the components, the external forces that affect the system, and the long-term behaviour of the system. One way to study a system is to build a model of the real system, that behaves sufficiently like the real system (Rubinstein, 1981). The model permits analysis of the behaviour of the system without impacting the real system (Moore, 1994).

There are a number of criteria that can be used to evaluate models (Walker, 1987). Is the model understandable? It is necessary to balance simplicity for ease of analysis with complexity for quality of conclusions. How accurate are model results? Conclusions drawn from a modelling exercise can extend to the real system but are limited to the extent that the abstraction adequately describes the real system. How applicable is the model to a number of applications? Models should be flexible to incorporate changes as more is learned about the problem. How applicable is the model to the system being modelled? Models must be designed to sufficiently

address the problem so solutions from the model may be practical solutions to actual problems.

A system model can be used to predict the future behaviour of the system and, to some extent, control it. Properly applied, conclusions drawn from the analysis of the model can aid in decision-making (Walker, 1987). At the least, a model can provide insight into the importance of the factors affecting the real system as well as the functioning of the system as a whole (Kleijnen, 1974).

#### TIMBER MANAGEMENT DECISIONS

The goal of timber management planning in Ontario is to plan the harvest, renewal and maintenance of the forest to ensure a supply of benefits from the forest. To achieve this, timber management plans are written for all Crown land in the province. Each plan defines objectives, methods and locations of activities for forest resource management (OMNR, 1986). Timber management plans are written for 20-year planning periods with specific activities identified for the first 5-year term.

Timber management plans document the decisions made today that will have effects far into the future. Part of the challenge in making these decisions is to consider the unknown needs of future generations (Duinker, 1994).

Timber management planning has been effective in establishing goals for wood supply (Duinker, 1994). The amount of fibre, by product, extracted from the forest each year is one example of a quantifiable target. Another may be to bring the forest into a regulated state in the shortest time possible.

Targets for other forest benefits have not been well reflected in timber management plans (Duinker, 1994). Other resource values are identified and treated as constraints in the course of planning timber management activities (OMNR, 1986). Caza (1994) criticizes this approach as both frustrating for timber planners and inadequate for others who advocate that forest level values like biodiversity be identified as forest management objectives.

One of the decisions the forest manager makes is how much wood (volume and area) to harvest in any planning period from the forest, as part of a long-term timber harvest profile. The harvest profile affects the structure of the forest over time (Davis, 1994a). Harvest level determination considers one or more of the following objectives:

1. To provide an even flow of wood from year to year to support the wood-using industry which depends on the wood fibre.
2. To support the provincial policy of sustained yield.



3. To provide a desirable mix of species to support changing market demand.
4. To ensure that silvicultural practices are consistent with the silvics of the species being managed.

In Ontario, the area control method of allowable cut determination as been redefined as the Maximum Allowable Depletion (MAD). MAD is the calculated area from which timber can be depleted by harvest, fire, insects, disease, inoperability or allocation to other forest uses (OMNR, 1986). The Ontario Wood Supply and Forest Productivity (OWOSFOP) computer simulation model is the current accepted method to determine MADs. In a shorter format, the MADCALC spreadsheet performs the same calculation (Kloss and Oatway, 1992).

Area regulation will convert an unmanaged forest into a forest with equal age-class distribution (normal) over one rotation (Willcocks et al., 1990). Equal areas are harvested and treated each year. The corresponding volumes harvested from these areas may vary from year to year, sometimes resulting in drastic shortfalls or surpluses of timber.

Willcocks et al. (1990) contrasted area regulation with volume regulation. While volume levels over time are constant, area harvested will fluctuate, requiring a longer period to balance the forest than with area regulation. The length of time will depend on the species and the initial age-class structure of the forest.

Under an evenaged silvicultural system, the MAD algorithm moves towards "normalizing" the forest. Calculating a MAD for a forest unit with a skewed age-class distribution will normalize in one rotation or shorter depending on whether an acceleration factor is used. For example, in a forest with a large area in the older age classes, a high acceleration factor will mean more area will be harvested in a shorter time than in a forest with a more uniform age-class distribution.

For each 5-year term of the timber management plan, a MAD is calculated and is available for harvest, by area, by forest unit. The MAD area is translated into stand allocations on the ground. Associated volumes are determined for the allocations from Forest Resources Inventory (FRI) figures or operational cruising (OMNR, 1986). The MAD algorithm determines the short-term wood supply from the unit and gives the forest manager a picture of the harvest profile, i.e. the long-term effect of the short-term strategy. The harvest profile dictates the future state of the forest system.

Simply put, the MAD exercise attempts to predict the future. Explicit assumptions are made that regeneration successes, subsequent free-to-grow levels and renewal rates for Not Satisfactory Regenerated (NSR) lands are constant (Kloss and Oatway, 1992). Losses due to uncertainties such as insects and disease are not addressed. Because only

losses due to roads and landings are explicitly incorporated, the productive forest land base is assumed to be static.

Methods to determine sustainable harvest levels have become more sophisticated since the development of the MADCALC algorithm (Moore, 1994). But because the MAD is the required method of harvest level determination in Ontario, these other methods can be used only as supplementary wood-supply analyses (OMNR, 1986).

Mathematical programming techniques are important tools to enhance timber management planning decisions (Martell, 1994). Models like the linear programming (LP)-based TimberRAM (Navon, 1971) and FORPLAN (Johnson et al., 1986) are optimization tools to determine the best management scenario from a set of management activities, given an objective function and a number of constraints (Jamnick, 1990). While used frequently in other jurisdictions, they are not widely used in Ontario.

Simulation models like FORMAN (Wang et al., 1987) and HSG (Harvest Schedule Generator) (Moore and Lockwood, 1990) are evaluation tools to assess user-specified forest management strategies, but do not identify optimal solutions (Martell, 1994). They use a trial and error approach to determine a strategy that meets forest management objectives (Davis, 1994b, Jamnick, 1990).

Martell (1994) pointed out that neither optimization models nor simulation models are appropriate for all applications. A balanced approach suggested by Martell (1994) utilizes the strengths of both approaches. The LP models scope the boundaries of a set of good solutions followed by human evaluation of the LP generated solutions using the simulation models.

Both simulation and optimization models treat spatial detail in one of two ways. The original version of FORMAN aggregates forest stands with similar development patterns into forest classes (Wang et al., 1987). The aggregation process can make it difficult to translate a solution into an operational plan (Martell, 1994). In contrast, the HSG wood supply model tracks the development of individual stands and retains their spatial identity throughout the models operation (Moore and Lockwood, 1990), facilitating the on-ground evaluation of the solution. To increase their usefulness, aggregation models like TimberRAM have been linked with a Geographic Information System (Lougheed, 1988).

To incorporate uncertainty into timber harvest decision making, the forest manager has several options. One is to ignore uncertain events and plan as though they will not occur in the future (Davis, 1994a, Boychuk and Martell, 1993). A second is to deduct a percentage of the landbase from productivity for each planning period

Martell, 1994). Another is to replan frequently. The approach taken in Ontario is to update forest inventories and determine MAD levels every five years (OMNR, 1986).

Forest managers have little guidance on how to plan should a catastrophic fire destroy some large portion of the timber resource. Could foresters plan effectively if the levels of forest fire destruction varied from year to year or from planning period to planning period? Constant percentage deduction would seem to be inadequate. What effect, if any, does the consideration of risk or uncertainty in decision-making have on the annual harvest level? By facing uncertainties and attempting to quantify them early in the planning process, managers can expect better results from their decisions (Fight and Bell, 1977). In addition, the forest manager must be flexible in planning to account for poor understanding of forest dynamics (Baskerville, 1986).

With the release of the Class Environmental Assessment it is expected that there will be changes to the methods of timber management planning in Ontario (Davis, 1994b). Davis (1994b) expects part of this to be a revision of the harvest level determination process for crown land. One of the new tools available to the forest manager will be the LP-based Strategic Forest Management Model (SFMM) (Davis 1993). Originally used to develop timber production options for the province, it is now being introduced to the

field manager as one of many tools available to determine harvest levels (Davis, 1994c). The model is a decision aid to determine the optimum forest management strategy that most effectively meets management objectives. Unlike other models, SFMM incorporates other forest level objectives like multiple use, temporary (deferrals) and permanent land withdrawals (reserves) and uses an deterministic approximation to reflect catastrophic events like fire, insect infestations and windthrow.

## FOREST FIRE RESEARCH IN FORESTRY

### Forest Fire Behaviour

Efforts to increase the understanding of wildfire as an uncertain forest process are well documented in forestry research literature. Renewal of boreal forest ecosystems is largely dependent on natural wildfire (Van Wagner, 1978). The present age-class structure of the forest reflects its fire history. Large areas of evenaged species are evidence of the naturally occurring disturbance pattern of the boreal forest.

The behaviour of a fire, once ignited, depends on the availability of fuel, weather, topography and the proximity of other fires. As a fire continues to burn it will increase in size and may change in intensity. At any one

time, different areas of the same fire may vary in intensity. Three levels of fire intensity have been identified by Van Wagner (1978). Catastrophic fires kill the existing stand and force forest regeneration to establish from bare land. Endemic fires are of sub-lethal intensity. These fires may leave only fire-scarred trees throughout the residual stand. Gentle fires may leave no record of their impact on the stand. However, even fires of less than catastrophic intensity may retard forest growth (Reed and Errico, 1985a).

#### Stand-Level Research

Forest fire research at the stand level has focused on determining the impact of forest fire on age-class distribution within stands and on rotation age. Van Wagner (1978) simulated the long-term effects of harvesting and fire on the age-class distribution of fire damaged stands. He assumed that flammability was constant with age, that logging occurred in the oldest age classes first and that following either type of disturbance, regeneration was immediate. He concluded that the number of fires and their associated areas had less impact on the age-class distribution than the total area burned each year.

Classical models that determine rotation age ignore the impact of catastrophic fires. In a new direction, Martel

(1980) presented a stochastic model that allows the forest manager to investigate the impact of probabilistic fire occurrence and fire management activities on rotation age determination. Like Van Wagner, Martell (1980) assumed that the probability of stand ignition and subsequent burning are age-independent. He concluded that as the probability of fire increased, the optimal rotation age decreased.

Routledge (1980) supported the use of stochastic models when studying the effect of forest fire at the stand level. Deterministic approaches for determining optimal forest rotation periodically review and revise predictions to account for uncertainties. The consideration of catastrophes such as fire or insect attacks are not included. Routledge questions the potential effect of ignoring these uncertain phenomena in forestry. The results of his analysis agree with those presented by Martell (1980).

Reed and Errico (1985a) developed a series of fire-adjusted volume rotation curves to study the effect of forest fire on rotation age. The optimal rotation length that maximizes long-run average yield, in the presence of fire, was determined using traditional graphical methods. Results were applicable to individual stands or to forests where stands are managed on an individual basis. They



concluded that even low rates of fire can lower forest yields at the stand level.

### Forest-Level Research

When considering the forest as a whole, it is necessary to consider the complex interactions among the components that make up the system. Ultimately, forest management decisions must be coordinated across the whole forest. Results from stand-level research may not apply directly at this larger scale.

For example, forest-level constraints, like even flows of wood over time, make it difficult to approach timber supply analysis from a stand-level basis (Dempster and Stevens, 1987). The determination of a sustainable harvest level in the presence of fire has been approached by a number of studies.

In his simulation model, Van Wagner (1983) studied the long-term impact of periodic destruction by forest fire on the equilibrium annual allowable cut (AAC). He set out to develop a model that would recognize and quantify the effects of forest fire on timber supply. In the model, a constant area was destroyed by fire each year. Burned stands were selected at random, regardless of age. Immediately following harvest, stands were regenerated and

developed along the same yield curve as they would have in the absence of fire.

As the percentage of area burned each year increased, the AAC decreased. The amount by which the maximum sustainable harvest level was reduced by fire was greater than the volume of the forest burned. In the same analysis Van Wagner (1983) suggested that a forest that is harvested below its maximum AAC is insensitive to damage by fire.

In their first published work on stochastic processes at the forest-level, Reed and Errico (1985b) designed an approach that described the evolution of a forest subject to periodic depletions by harvesting and random fire through a set of dynamic equations. They proposed that their deterministic approach was a reasonable solution of the stochastic fire problem.

In later research, Reed and Errico (1986) developed a forest level model that accounted for random losses due to fire. The problem was structured as a stochastic problem and an approximate solution was found using an iterative linear programming approach.

Because a single forest type was used in the study, forest growth was determined by one yield curve. Randomly generated proportions in each age class were destroyed by fire and regeneration of stands was assumed to occur immediately after depletion.

The presence of low rates of fire resulted in lower harvest levels than when fire was not included. This led Reed and Errico (1986) to suggest that current timber supply levels determined at the forest level that ignore catastrophic forces are too high.

Reed and Errico (1986) did not address accessibility restrictions and salvage possibilities. Economic factors such as uncertainty in the demand for timber and associated stumpage values were also not considered.

In their more recent research, Reed and Errico (1989) have addressed some of the shortcomings of their earlier models. Separate models have been developed to consider salvage of burned timber, describe multiple timber types, incorporate various regeneration schemes, and deal with accessibility or spatial constraints.

FIRFOR, for FIRE FOREst Management, is a framework developed by Newnham (1987) as the foundation for an ongoing forest management decision support system. FIRFOR aids managers in selecting the best management strategy given a set of operating conditions. The purpose of the model is to illustrate the effect of forest fire on long-term forest yield and to explore different harvest schedules to lessen the impact of fires.

The model accepts variations in annual areas burned to determine their effect on annual harvest levels, while considering different forest management strategies. As in

earlier research, stand flammability was treated as age dependent. Salvage of timber was incorporated, and, once depleted, stands were regenerated without delay and then followed their original growth curve. Newnham (1987) used a homogenous forest with a uniform age-class distribution as a case study.

Dempster and Stevens (1987) designed a harvest scheduling model that included a yield projection system and a harvest scheduling system. They concluded that the probability of harvesting a projected volume of wood decreases with time in the presence of fire. Reducing rotation age led to higher expected harvest levels, but the increase was small compared to the effect of reducing forest fire potential. In other words, harvest levels can be best increased by forest fire and pathogen prevention programs, rather than harvesting younger timber.

Risk-adjusted harvest scheduling, i.e. queuing stands for harvest according to flammability, was an attempt by Dempster and Stevens (1987) to reduce the probability of occurrence of severe fires.

Dempster and Stevens (1987) suggested that the long-term projected harvest level should not be constrained by current harvest levels. They argued that destruction by forest fire and the possible futures of the forest are in themselves, random. Instead, they argue for short planning periods and flexible constraints on harvest levels. They

agreed that risk should be directly incorporated into operational harvest scheduling.

Incorporating uncertain forest processes like wildfire into wood supply modelling in Ontario began only recently. Martell (1994) described the impact of fire on timber supply in Ontario. He determined an optimal harvest schedule using a LP-based model for a fully accessed, single species forest subject to different annual rates of forest fire. As the amount of forest area burned each year increased, the harvest level decreased.

Boychuk and Martell (1993) determined harvest levels for a hypothetical single species forest subjected to losses by two methods. First, fire losses were modelled as annual averages. Under this scenario, the reduction to the annual harvest level was greater than the average amount of forest burned annually.

In the second method the forest was subjected to varying rates of fire losses. Boychuk and Martell (1993) tested the effects of different regulation strategies on harvest levels. Under an age control method, i.e. all stands are harvested at a certain age, there were considerable variances in harvest volumes over time. Under an area control regime less variance in harvest volumes occurred than with age control. Under a volume control method, harvest volume variances were least of the three methods.

Boychuk and Martell (1993) presented a number of options to deal with the uncertainty of forest fire in timber management planning. The first is to harvest stands before the age at which they are expected to burn. This will increase both the harvest level and the harvest of younger stands. The second option is to build a buffer of available timber in case a large fire occurs. This is done by reducing harvest levels and increasing the age at which stands are harvested.

More recently, the SFMM model explicitly incorporates rates for natural disturbances such as fire, windthrow and lethal insect infestations into the model (Davis, 1994a). Like that of Boychuk and Martell (1993), the model uses annual average disturbance rates to account for fire losses. In SFMM these rates are further refined for multiple species types and for the management unit being analyzed. It is expected in further refinements to the model that salvage volumes associated with losses will be incorporated. As SFMM becomes adopted for use at the management unit level, its usefulness can be assessed. Given the advancements into research on forest fire risk, the question still remains: how do we incorporate changing rates of fire into an operational wood supply model for use by forest managers?

## CHAPTER III. FORMAN AS AN OPERATIONAL PLANNING TOOL

FORMAN, for FOREst MANAgement, is a deterministic computer simulation model (Wang et al., 1987). The model allows the forest manager to explore the long-term effects of alternative forest-level management strategies on harvest levels and future forest structure. The user can change initial conditions, harvest strategies, harvest sequencing and silviculture strategies. FORMAN is not appropriate for stand-level analysis.

To evaluate alternative management strategies, the model involves three steps. First, the forest is defined in its present state. Second, the FORMAN forest is described by time-related development functions. Third, external forces such as harvesting and silviculture are described and their effects on the forest system quantified.

FORMAN is useful to evaluate forest-level questions such as wood flow over time. The basic forest unit used in the model is called the forest class. Stands similar in age, species composition and site productivity are grouped together into forest classes. The forest inventory is then represented by an aggregation of all the forest classes. In addition to age and area, each forest class is described

by its expected development pattern.

Unlike traditional growth and yield modelling, where stand-level yields are model outputs, FORMAN requires estimates of stand yields as inputs. Thus, in FORMAN, stand yield is solely a function of time and does not capture the dynamic relationship between stand growth and yield. The development of each forest class is described by three curve sets. The first curve set describes the natural development pattern of the forest class over time, in the absence of human intervention and catastrophic disturbance. The second curve set describes the future development pattern of the forest class in response to harvest followed by natural regeneration. The third curve set describes the expected development pattern of the forest class in response to artificial regeneration following harvest.

Up to five time-related curves can make up a curve set. Expected changes in primary volume, secondary volume, product percentage, e.g. sawlogs and pulp, and harvesting costs can be expressed as time-related curves.

The first step to defining the management strategy is to choose a set of rules (called harvest rules) to prioritize forest classes for harvesting. There are seven possible harvest rules that can be selected. Three of the seven are chosen for first, second and third priorities for queuing forest classes for harvest. Unharvested primary



volume loss, harvested secondary volume and harvesting cost can be minimized. Harvesting costs are average costs of harvesting and forwarding wood to roadside.

Primary volume harvested, secondary volume harvested and product percentage can be maximized. A user-specified harvest rule can also be chosen. Any harvest rule can have priority in any iteration for a user-specified length of time.

The second part of the management strategy sets proposed harvest levels, expressed as volume, and planting and spacing targets, expressed as area. The model incorporates a mechanism, the harvest sequence file, to prioritize forest classes for harvesting that will override the harvest rules. This may be a valuable tool when the salvage of fire or insect damaged stands is desired.

Forest development is simulated in five-year intervals. The forest is harvested according to the harvest rules or, if present, by the harvest sequence file up to the five-year harvest level. Harvesting progresses through the sequence of eligible stands until the specified primary-volume harvest level is reached or until the growing stock is depleted. As harvest volumes are generated for primary volume, secondary volumes, product volumes and harvest costs are calculated.

Following harvesting, cutover areas are planted according to the specified planting level. If the planting

level falls short of the harvested area, the remaining forest classes follow their natural development pattern. Stands are spaced in a similar manner.

To simulate growth of the forest, at the end of each interval the age of each forest class is incremented by five years, the forest inventory is updated, and the process repeats itself (Figure 1).

Once the model has run for the length of the planning horizon, forest statistics are available in a number of formats. The report on the forest contains the volume and area cut, divided into primary species, secondary species and product (e.g. veneer). Costs of harvesting, planting and spacing are also available. Mortality, both potential and realized, are displayed. The model will also produce, in report format, the evolution of the age-class distribution over the planning period.

#### EVALUATION OF THE MODEL

Jamnick (1990) evaluated FORMAN as a planning tool. FORMAN is the model of preference over LP-based models for simple harvest scheduling problems. FORMAN has become popular in such cases because the model is easy to understand and the steps to formulate the harvest level are straightforward. When the harvest level is determined considering only sustained-yield objectives, the model is

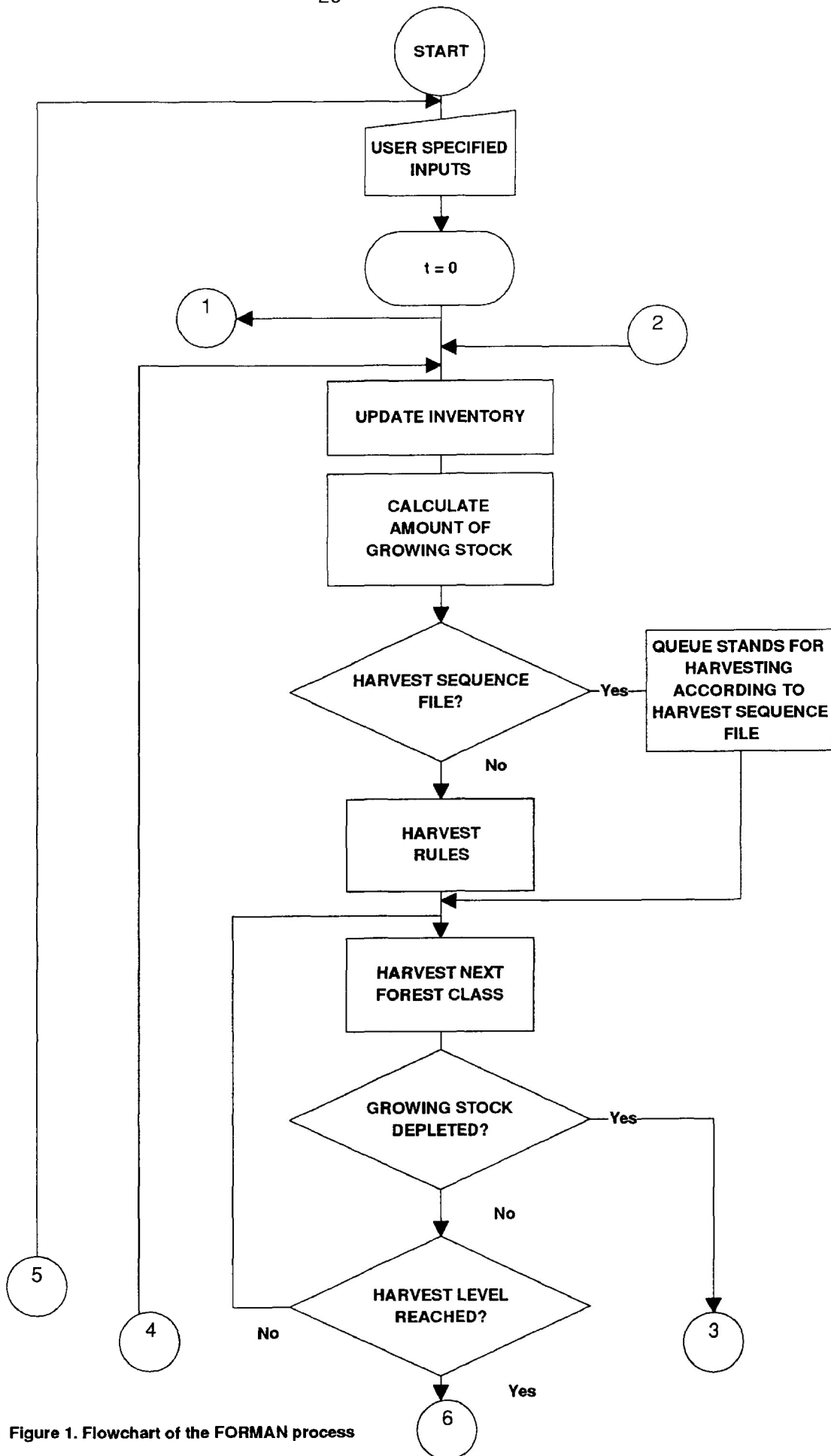

Figure 1. Flowchart of the FORMAN process

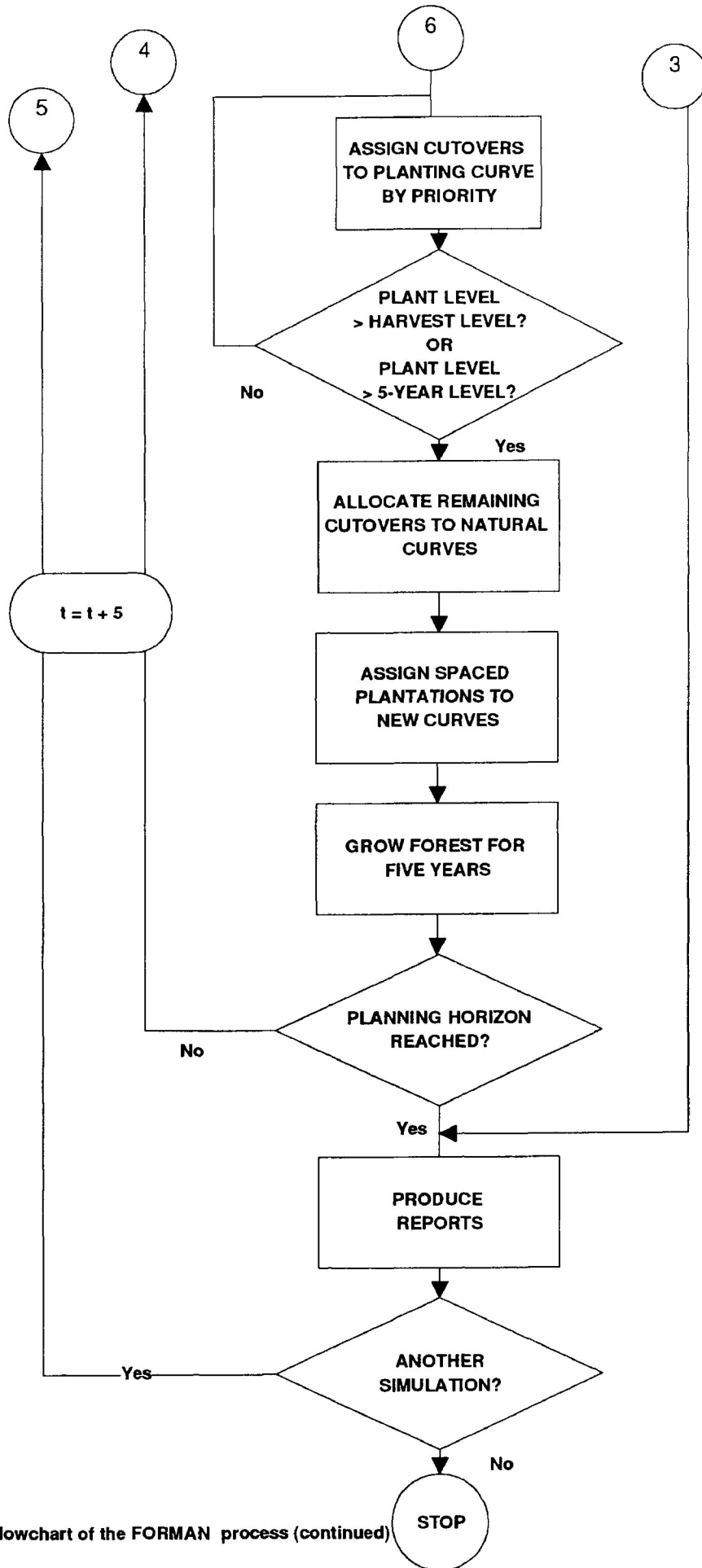

Figure 1. Flowchart of the FORMAN process (continued)

adequate. Where the economics of wood supply are not a concern, the model is preferable over LP-based models.

#### MODIFICATIONS OF FORMAN

The original version of FORMAN is useful for analysis of management strategies in evenaged clearcut silviculture systems. Four variations of the model have been developed to address other management options. NORMAN was developed by the former Northern Region of the OMNR to reflect the varied levels of management intensities in that area's forests while considering the effects of budget constraints on wood supply. FORMANWT (FORMAN With Thinning) was developed for commercial thinning applications. In addition it can simulate the partial cutting methods in the shelterwood and selection management systems. FORMANCP (FORMAN Crop Planning) was developed to include economic analysis and graphic capabilities (Williams, 1991). FORMAN-WILD, a modified version of FORMAN, evaluates the effect of forest management regimes on timber supply and marten populations (Willcocks and Watt, 1994).

Since the development of the FORMAN model described here, two refinements of the model have been developed. The first, FORMAN+1, builds upon the principles and approaches found in the earlier version, and offers a number of refinements (Roussell et al., 1991). The range

of stand treatments has been expanded to account for any possible forest management intervention provided the post-treatment response to the treatment can be quantified.

The options for harvest and silviculture priorities have been increased through an expanded set of rules, similar to the harvest rule concept in the original model. To recognize the importance of other forest values, the forest inventory can be assessed for habitat availability for wildlife species.

The second model that is currently under development is FORMAN+2 (Vanguard Forest Management Services, 1993). It is a inventory projection model that can be used to evaluate unevenaged management strategies. The growth projection model STAMAN simulates stand-level dynamics. It can be used as a stand-alone product to develop stand level prescriptions or as part of the forest-level simulation using FORMAN+2.

#### KIMBERLY CLARK APPLICATION

Kimberly Clark Limited (KC) in Longlac, Ontario, used the original version of FORMAN for its internal forest management planning in preparation for the 1990 timber management plan (Forbes, 1988). KC adopted the FORMAN model to determine its strategy to meet the company's wood supply objective for a number of reasons. In the mid

1980's the OMNR identified a potential long-term wood supply problem. Supply shortages were identified primarily in the spruce forest units. Declining harvest levels prescribed by the Ontario Wood Supply and Forest Productivity (OWOSFOP) model were unacceptable to KC to meet its mill objectives. In response, innovative harvest and regeneration strategy options were designed to meet mill requirements. The FORMAN model allowed KC staff to evaluate these options to best meet the long-term fibre requirements.

The risk of fire was not identified as an issue in KC's 1990 timber management plan. KC relies on traditional forest-fire protection programs to deal with the risk of fire on the Nakina forest.

## CHAPTER IV. THE BURN SUBPROGRAM

In the models presented in Chapter II, a constant forest area is burned in each period during the model's operation. The algorithm developed here burns a variable forest area per time unit. Over time, the area burned fluctuates to simulate historical patterns. The subprograms NOSTART.FOR and AREA.FOR incorporate the historical forest fire occurrence and burned area patterns, respectively. The risk of wildfire is treated in a separate process, BURN.FOR, which when linked to the execution of FORMAN (Figure 2) results in FORMANB.FOR, a new version of the original program.

At the beginning of each five-year interval, before FORMAN completes an inventory update, forest fire may occur. Any changes to the forest classes as a result of fire are incorporated into the structure of the forest before any harvesting activity for that iteration.

On transfer of control from the FORMAN program to the BURN subprogram, the algorithm simulates forest fire occurrence according to historical patterns. Before control is transferred back to FORMAN, BURN updates the forest inventory. The BURN algorithm is executed through a number of subprograms (Figure 3). The FORTRAN code for



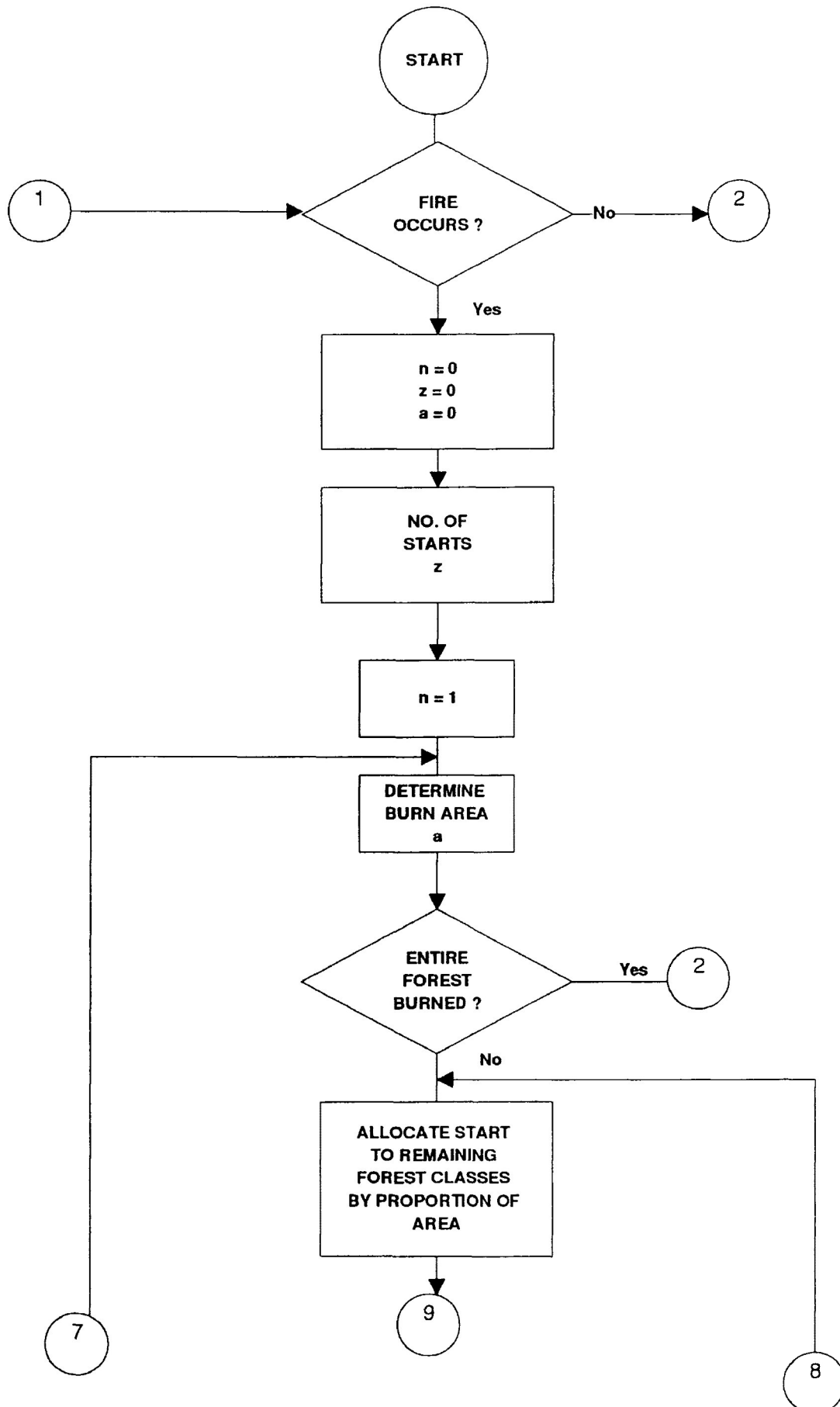

Figure 2. Flowchart of the BURN Algorithm

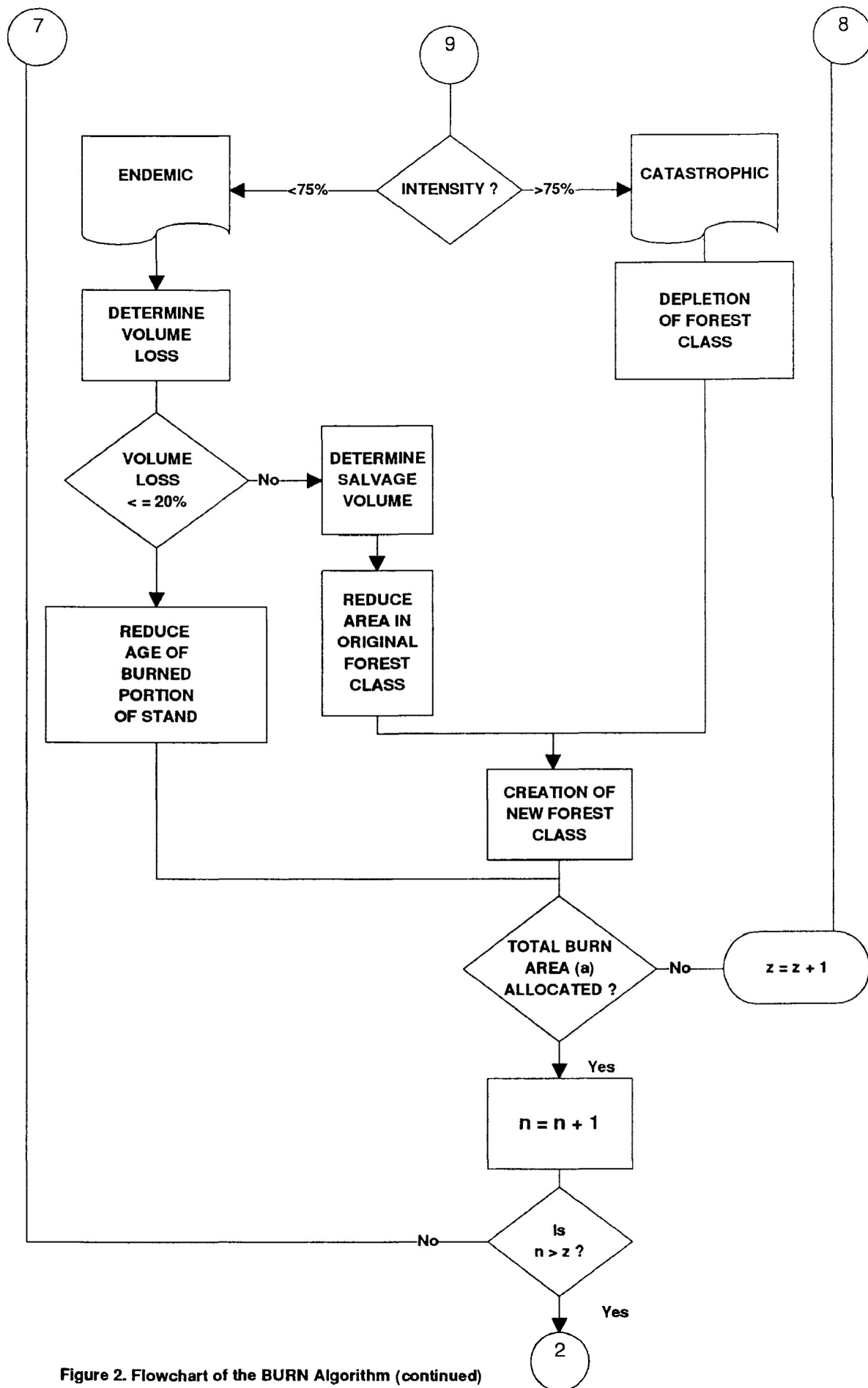

Figure 2. Flowchart of the BURN Algorithm (continued)

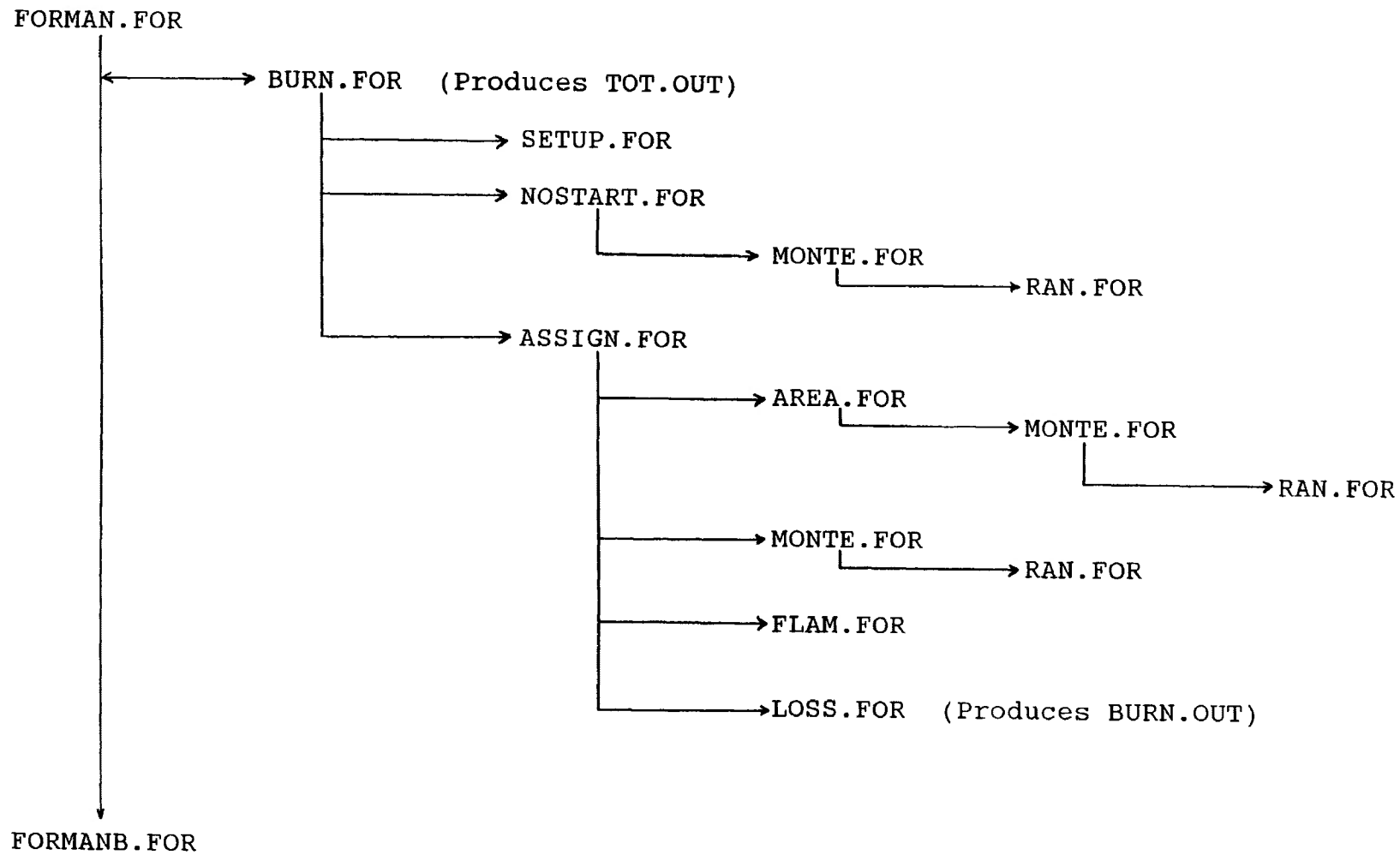

Figure 3. Schematic Diagram of BURN and Link to FORMAN

BURN and its subprograms are found in Appendices A-1 to A-10.

Each time BURN is invoked, the inventory has changed, i.e. new forest classes have been formed while other forest classes have been depleted through harvesting by FORMAN. The subprogram SETUP sets up an area distribution that describes individual forest classes as a portion of the total forest area. This distribution is used later in the execution of BURN. BURN then determines the number of fire starts. The number of starts (NOSTART) is described by a distribution of historical forest fire occurrence records.

The Monte Carlo algorithm (MONTE) is invoked in three places in BURN. The process follows that described by Newbold (1986). MONTE requires two parallel distributions of numbers. The first is an array of upper values defining one distribution. For example, when NOSTART calls MONTE, the first distribution passed is an array of real numbers defining the upper range limits of the annual number of forest fire starts.

The second distribution in MONTE defines a series of integer values that point to the intervals defined in the first distribution. In the same example, the second distribution passed from NOSTART is the number of starts in the iteration. To function, MONTE calls the subprogram RAN for a random number. MONTE takes this random number and compares it with the first distribution. MONTE searches the first distribution for the interval where the random

number fits. When found, this location corresponds to a unique integer value from the second distribution. In NOSTART this is the number of starts for the iteration. The programs AREA and ASSIGN call MONTE in the same way to determine burned area and forest class assignment for the burn, respectively.

In the first pass through BURN the user is prompted for a seed for the random number generator RAN. The RAN subprogram returns a four-digit integer value to begin program execution.

An area burned by each fire start (AREA) is randomly drawn from a distribution developed in the same manner as that in NOSTART. Next, the fire start is assigned to a forest class by the subprogram ASSIGN. Each forest class has a chance of being drawn proportionate to the area in that forest class. Simply put, a fire is more likely to occur in a larger forest class than in a smaller one.

Flammability, for the purpose of this analysis, is a function of species and site. Because forest units are aggregated in the same manner, each has a unique flammability factor. Flammability is assigned in the subprogram FLAM.

Once an area is burned there is an associated volume burned. This will affect primary, secondary and product volumes. Fire intensity is expressed as volume loss. The more intense the fire, the higher the volume loss. Fire

intensity is assumed to be uniform throughout the total area depleted by fire. Forest stands with the same age are aggregated into forest classes. It follows, then, that each forest class has a unique flammability factor. The percentage of the volume burned that will be lost is determined by a function of the flammability factor and age. Volume loss is expressed as a percentage loss for each stand in the subprogram LOSS. Volume lost through fire is not available for salvage.

A volume loss of less than 20% is a gentle burn of low intensity. In response, the age of forest class is reduced, essentially sliding the forest class back down its development curve. Given the manner in which FORMAN simulates forest yield, this is a reasonable approach.

Catastrophic loss is a volume loss of 75% or more. Salvage potential occurs when the volume loss is less than 75% but greater than or equal to 20%. This volume is available for harvest in addition to the regular harvest, in any iteration, as a separate operation. This is consistent with present strategies for salvage operations in the province. Salvage volumes are the difference between the operable volumes (primary, secondary and product) on the area burned less the volume loss.

After volume losses are calculated for catastrophic and moderate fires, primary, secondary and product volumes are recalculated for each forest class. Once a portion of

a forest class is burned, the area is deducted from the forest class. The burned area becomes a new forest class with the same development patterns as the pre-burn forest class.

If the burn area in any start is larger than the area in the forest class to which it is assigned, that class is depleted and the remaining burn area is allocated to another forest class. This process is repeated until the total burn area has been assigned. Once all starts have been assigned for the iteration, the forest inventory is updated and control returns to FORMAN.

The report BURN.OUT tracks the burn activity for each 5-year iteration (Table 1). Burn statistics are summarized in a Burn Profile (TOT.OUT) for each 100-year simulation Run (Table 2).

Table 1. A sample of output from subroutine LOSS.FOR. The body of the table contains summary statistics for 14 simulated fires that occurred during a single 5-year interval (years 20 to 25) within simulation run 7.

RECORD OF BURN FOR YEAR 25									
START NUMBER	FOREST CLASS	NEW AGE	AREA	PRIMARY VOL BURNED	SECONDARY VOL BURNED	PRODUCT VOL BURNED	SALVAGE VOL CAPTURED PRIMARY	SALVAGE VOL CAPTURED SECONDARY	SALVAGE VOL CAPTURED PRODUCT
			(ha)	(m3)	(m3)	(m3)	(m3)	(m3)	(m3)
1	113	85	82	.00	.00	.00	.00	.00	.00
2	86	55	416	.00	.00	.00	.00	.00	.00
3	157	15	416	.00	.00	.00	.00	.00	.00
4	113	85	1	.00	.00	.00	.00	.00	.00
5	138	95	416	39520.00	9984.00	.00	.00	.00	.00
6	113	85	1	.00	.00	.00	.00	.00	.00
7	108	30	5	.00	.00	.00	.00	.00	.00
8	56	105	4	524.00	112.00	.00	.00	.00	.00
9	138	95	41	3895.00	984.00	.00	.00	.00	.00
10	165	5	58	.00	.00	.00	.00	.00	.00
11	165	0	1651	.00	.00	.00	.00	.00	.00
12	164	10	4	.00	.00	.00	.00	.00	.00
12	142	35	1	.00	2.00	.00	.00	1.44	.00
13	161	10	1651	.00	.00	.00	.00	.00	.00
14	110	50	2	.00	.00	.00	.00	.00	.00
<b>TOTAL</b>			4749	43939.00	11082.00	.00	.00	1.44	.00



Table 2. A sample of output from subroutine BURN.FOR. The body of the table contains summary statistics for 312 fires that occurred during the 100 years of simulation run 7.

SUMMARY BURN PROFILE

TIME	NO. OF BURN STARTS	AREA (ha)	PRIMARY VOL BURNED (m3)	SECONDARY VOL BURNED (m3)	PRODUCT VOL BURNED (m3)	SALVAGE PRIM VOL (m3)	SALVAGE SEC VOL (m3)	SALVAGE PROD VOL (m3)
5	7	2718	19207.00	23571.00	.00	4579.32	10160.64	.00
10	30	9076	519459.00	110248.00	.00	111742.70	20398.87	.00
15	18	9151	145596.00	369382.00	.00	85266.43	234777.70	.00
20	21	6739	204837.00	135370.00	.00	32049.39	64800.00	.00
25	14	4749	43939.00	11082.00	.00	.00	1.44	.00
30	11	2674	18280.00	3261.00	.00	4406.88	367.08	.00
35	6	2890	42547.00	55650.00	.00	24524.12	41459.25	.00
40	5	181	135.00	363.00	.00	94.50	254.10	.00
45	7	5344	3382.00	8454.00	.00	2240.75	6078.27	.00
50	9	4220	169616.00	3634.00	.00	75022.72	2691.28	.00
55	7	187	.00	.00	.00	.00	.00	.00
60	7	218	8700.00	2219.00	.00	.00	26.40	.00
65	8	907	12168.00	3451.00	.00	104.16	270.60	.00
70	5	2327	62538.00	7002.00	.00	32239.20	3469.60	.00
75	26	15714	107094.00	95085.00	.00	19906.28	38468.69	.00
80	9	7281	3628.00	13863.00	.00	128.80	7419.76	.00
85	18	5000	178957.00	47057.00	.00	20846.04	5526.68	.00
90	34	5707	4768.00	15632.00	.00	2375.20	7539.80	.00
95	63	16079	.00	105014.00	.00	.00	51505.92	.00
100	7	883	.00	273.00	.00	.00	109.20	.00
<hr/>								
TOTAL	312	102045	1544851.00	1010611.00	.00	415526.50	495325.30	.00

CHAPTER V. EFFECT OF FIRE ON  
SUSTAINABLE HARVEST LEVELS

FOREST DESCRIPTION

The total area of the Nakina Forest is 905,924 hectares. The total Crown production forest land base is 724,171 ha or 80% of the landbase (Forbes, 1990).

The spruce working group has been divided into three forest units. These are lowland spruce (Picea mariana (Mill.) B.S.P.), upland spruce (Picea glauca (Moench) Voss) and spruce site class 3. The other working groups have been assigned to the forest units jack pine (Pinus banksiana Lamb.), balsam fir (Abies balsamea (L.) Mill.), white birch (Betula papyrifera Marsh.) and poplar (Populus tremuloides Michx.).

Because of a lack of major natural disturbances in the spruce working group recently, most of the forest is overmature, with the exception of the jack pine forest units. Age-class distributions, by species, are found in Appendices B-1 to B-7. Most of these forest units are under the age of 100 years.

Spruce forest units are dominant on the Nakina forest. Most of the spruce in the north of the forest is lowland and overmature. The annual allowable cut calculation and

the "oldest first" principle dictated that these stands be harvested first. As a result, very little upland spruce is available for harvest. To balance the allocation for seasonal harvests, KC divided the spruce X,1, and 2 forest units into upland and lowland forest units (Forbes, 1988). A stand was considered upland if it contained 20% or more of jack pine, white birch, balsam, poplar or white spruce in the species composition.

#### HARVEST SCHEDULING IN ABSENCE OF FIRE

Forest Resources Inventory (FRI) data, updated to 1990, were used as the base inventory for Kimberly Clark's wood-supply analysis. The three yield curves used by KC to make up a curve set were primary volume expressed as conifer volume, secondary volumes expressed as hardwood volume, and harvest costs for primary volume harvested.

A number of input values remained constant throughout the FORMAN simulation runs to determine a sustainable harvest level (Table 3). Harvest rules were adjusted to ensure an optimal species mix (Forbes, 1990). Copies of the forest class file, silviculture cost file and curve set file for the Nakina forest are found in Appendices B-8 to B-10.

Table 3. Input Parameters for FORMAN simulations for the Nakina Forest.

---

Curve set file:	yield.viv
Forest Class file:	grostk.nak
Cost File:	silvcost
Harvest rules:	1. 75% of total harvest
	1st Minimize unharvest primary volume loss
	2nd Maximize harvested primary volume/ha
	2. 25% of total harvest
	1st Minimize harvested secondary volume/ha
	2nd Maximize harvested primary volume/ha
	3rd Minimize unharvested primary volume loss
Planting levels:	1000 ha/year
Spacing levels:	0 ha/year

---

Source: Forbes, R. 1988

### Sustainable Harvest Level

Wood-using industries need an even flow of wood in order to maintain continuous operations. As a result, industrial forest managers are much concerned with the problem of determining the maximum level of forest harvesting that is sustainable over the long run. Although "long run" in this context might mean "forever", in practice it often means a long, but finite, planning period. In this thesis, I have used a planning horizon of 100 years as is commonly done in Ontario.

Forest managers who use FORMAN to determine the sustainable harvest level do so by means of the following trial-and-error search technique. At each iteration of the search, the forest manager, in effect asks FORMAN, "Can the harvest level now being tested be sustained to the planning horizon?". The answer is "yes", if the FORMAN simulated forest does not run out of wood before the end of the planning period. If the harvest level being tested is sustainable, the forest manager increments the harvest level (e.g. by 1000 m<sup>3</sup>/year as I did) and runs FORMAN again. This search pattern is continued until an acceptable harvest level is found.

Once the maximum sustainable harvest level has been found, the associated harvest schedule is checked to ensure

that it is acceptable in every respect. An acceptable harvest strategy has all of the following characteristics.

it is sustainable over the full planning period,  
its silvicultural implications are affordable,  
and

it results in an acceptably stable flow of wood  
fibre over the planning period.

Results simulated by FORMAN for the Nakina Forest predict that the sustainable harvest level is 520,000 m<sup>3</sup>/year for the 1990-95 period. See the FORMAN short report in Appendix B-11 for details. It is important to note that at this level of harvesting, the growing stock of primary species on the (approximately 566,750 ha, reduced from 724,171 ha due to landbase reductions and operability constraints) Nakina Forest is reduced from about 21 million m<sup>3</sup> (an average of 38 m<sup>3</sup>/ha) at the beginning of the simulation to 2.6 million m<sup>3</sup> (an average of 4.7 m<sup>3</sup>/ha) at the end. While this may seem to be a drastic reduction, the following two points help place this result in perspective.

1. In order to support an annual harvest of 520,000 m<sup>3</sup>, the Nakina Forest must produce less than 1 m<sup>3</sup>/ha/year. This is easily achieved rate of growth in the boreal forests of northern Ontario.
2. The simulated growth rate at the end of the 100-year planning period is almost exactly the harvest level, and consequently at least temporarily sustainable. This is clear from the fact that the simulated level of growing stock in primary species in year 100 is almost identical to that of year 95.

Taking these points into consideration, I have decided to proceed as if a harvest level of 520,000 m<sup>3</sup>/year is in fact sustainable for 100 years on the Nakina Forest if not indefinitely. This is the harvest level that I use as a point of reference for judging the effects of wildfire. In adopting this harvest level the forest manager should proceed with caution. As a first step, the manager should use FORMAN to examine effects of such a strategy well into the second 100 years.

#### HARVEST SCHEDULING WITH RISK OF FIRE

In this study the number of fire starts and area burned is based on 30 years of forest fire occurrence records of the former OMNR Geraldton district (Table 4). This historical record tracks the total number of forest fires occurring in the district each year. The problem of relating the fire history of a very large area to a smaller portion was encountered. A percentage reduction based on area was not considered realistic. Instead, because of the inaccessibility of the Nakina forest, only naturally occurring forest fires were used for this analysis. To reflect this, the number of fire starts was reduced to 28% of the district values. Figure 4 displays the data contained in Table 4 in a scatterplot diagram. There is a wide variation between the number of fires and

Table 4. Historical Forest Fire Statistics -  
Geraldton District (1957-1989).

YEAR	NUMBER OF FIRES	BURN AREA (ha)
1957	72	287
1958	35	102
1959	39	54
1960	73	2309
1961	55	123
1962	224	18
1963	70	378
1964	24	488
1965	32	3833
1966	46	488
1967	22	5292
1968	29	13
1969	29	94
1970	85	3460
1971	65	1988
1972	166	10998
1973	10	822
1974	30	78881
1975	49	1652
1976	120	158733
1977	44	72650
1978	22	4044
1979	55	2544
1980	76	21549
1981	92	48269
1982	31	116
1983	107	73216
1984	24	9973
1985	19	10
1986	41	3643
1987	45	3897
1988	53	3052
1989	152	76800

Source: OMNR Statistics  
1957-1989



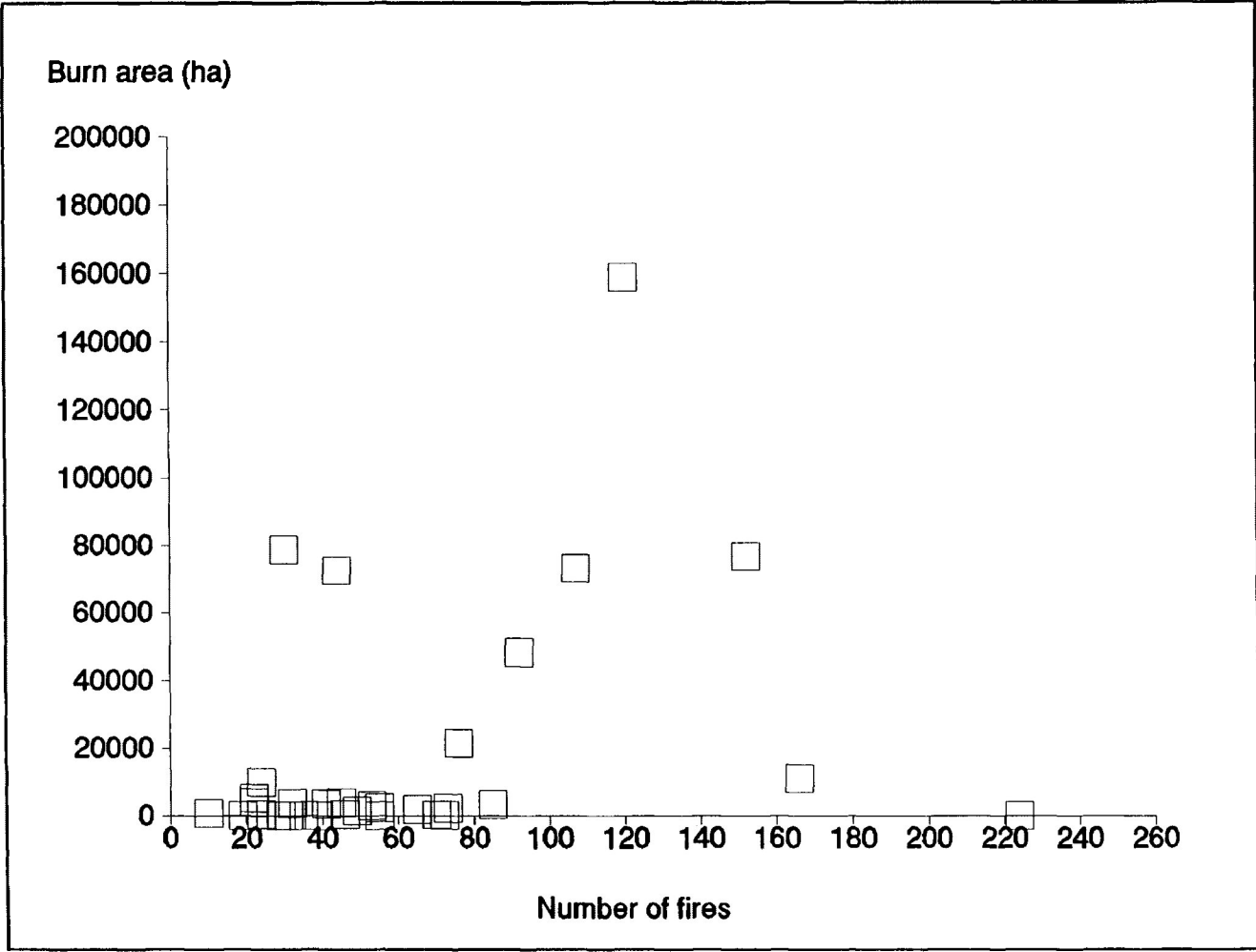

Figure 4. Burn area vs number of fires of 30 years from historical forest fire statistics from Geraldton district (1957-1988).

corresponding area burned.

The same input parameters from Table 3 were held constant throughout the FORMANB simulations. In addition, the primary volume level was restricted to a 5% fluctuation from period to period. The mean sustainable harvest level from 20 simulation runs (Table 5) was 473,500 m<sup>3</sup> per year. Figure 5 shows a rank-order listing of the sustainable harvest levels from the 20 simulation runs. There is a cluster of harvest levels within a narrow range between 470,000 m<sup>3</sup>/year and 475,000 m<sup>3</sup>/year. Table 6 summarizes the burn statistics from the 20 FORMANB simulations. On average 306 fires occurred during each planning period. The average burned area per fire start across the simulation runs is 282 ha.

Summaries are provided for the volume statistics from each of the short reports for each simulation run. Table 7 displays the simulation runs ranked according to increasing burned area. Table 8 and Table 9 reorder the simulation runs by increasing primary volume harvested and by primary volume Lost, respectively. Table 10 compares burn area and growing stock for each of the 20 simulation runs.

Figure 6 is a scatterplot of the burn area and the corresponding total growing stock at year 100, for each of the 20 simulation runs. Variation in the amount of burn area does not appear to affect the total growing stock at year 100. In some simulation runs forest fire increased

Table 5. Sustainable harvest levels from twenty (20) 100-year simulation runs with FORMANB.FOR.

SIM NO.	HARVEST LEVEL (1000 m3/year)
1	474
2	475
3	478
4	478
5	480
6	478
7	472
8	471
9	482
10	462
11	474
12	471
13	471
14	475
15	473
16	474
17	474
18	466
19	471
20	471

Harvest level interval	Maximum sustainable harvest level (units = 1000 m3)
462-463	462
464-465	
466-467	466
468-469	
470-471	471, 471, 471, 471, 471
472-473	472, 473
474-475	474, 474, 474, 474, 475, 475
476-477	
478-479	478, 478, 478
480-481	480
482-483	482

Figure 5. A rank-order listing of the maximum sustainable harvest levels obtained from twenty (20) 100-year simulation runs of FORMANB.FOR.

Table 6. Summary of BURN statistics for twenty (20) 100-year simulation runs.

SIM NO.	NO. OF STARTS	BURN AREA  (ha)	AVERAGE FIRE SIZE  (ha)	PRIMARY VOLUME BURNED (1000 m3)	PRIMARY VOLUME SALVAGED (1000 m3)	PRIMARY VOLUME LOST (1000 m3)	PRIMARY VOL LOST /HA BURNED m3	SEC VOLUME BURNED (1000 m3)	SEC VOLUME SALVAGED (1000 m3)	SEC VOLUME LOST (1000 m3)	SEC VOL LOST /HA BURNED m3
1	279	77563	278	1419	454	966	12	341	121	221	3
2	263	93066	354	1277	452	825	9	884	513	371	4
3	245	79725	325	1082	137	946	12	385	111	274	3
4	273	89162	327	1597	458	1138	13	904	472	432	5
5	338	80390	238	1666	482	1184	15	588	261	326	4
6	243	85057	350	1318	242	1076	13	464	148	317	4
7	312	102045	327	1545	416	1129	11	1011	495	515	5
8	348	91784	264	1977	704	1273	14	469	197	272	3
9	300	65090	217	1203	413	790	12	762	420	342	5
10	375	103156	275	2335	764	1571	15	664	259	405	4
11	308	85495	278	1340	409	931	11	655	334	320	4
12	311	92322	297	1862	463	1399	15	1030	510	520	6
13	379	98225	259	2153	652	1501	15	915	448	467	5
14	325	83018	255	1013	281	732	9	367	134	233	3
15	321	80964	252	1779	395	1384	17	577	205	372	5
16	300	80750	269	1880	453	1427	18	784	297	486	6
17	325	88838	273	1763	591	1171	13	1034	577	457	5
18	287	84768	295	1957	663	1294	15	1235	672	563	7
19	320	78699	246	2264	626	1637	21	945	426	519	7
20	277	71122	257	1660	387	1272	18	429	119	310	4
MEAN	306	85562	282	1654	472	1182	14	722	336	386	5

Table 7. Summary of FORMANB short reports, ranked by burn area, for twenty (20) 100-year simulation runs.

SIM NO.	BURN AREA (ha)	PRIMARY GROWING STOCK YEAR 100 (1000 m3)	SECONDARY GROWING STOCK YEAR 100 (1000 m3)	PRIMARY VOLUME HARVEST (1000 m3)	SECONDARY VOLUME HARVEST (1000 m3)	POTENTIAL MORTALITY (1000 m3)	REALIZED MORTALITY (1000 m3)
No-burn	0	2628	1977	52000	15582	176	12
Run 9	65090	1955	1916	48200	13862	199	18
Run 20	71122	1884	1932	47100	14447	213	22
Run 1	77563	3637	2295	47400	13861	411	21
Run 19	78699	1006	2738	47100	13307	192	14
Run 3	79725	1054	1454	47800	14353	263	22
Run 5	80390	3542	1330	48000	14438	226	10
Run 16	80750	3679	2143	47400	14010	182	19
Run 15	80964	1359	1907	47300	14381	211	22
Run 14	83018	1261	1928	47500	14056	212	18
Run 18	84768	757	1689	46600	13951	203	21
Run 6	85057	1336	2525	47800	14069	215	20
Run 11	85495	2730	2156	47400	14076	226	19
Run 17	88838	1598	1947	47400	14014	205	22
Run 4	89162	475	1650	47800	14005	188	16
Run 8	91784	200	1884	47100	14142	209	23
Run 12	92322	817	1638	47100	13510	195	19
Run 2	93066	1119	2293	47500	13948	211	21
Run 13	98225	1003	1862	47100	13707	297	17
Run 7	102045	1146	2136	47200	13913	211	19
Run 10	103156	678	1698	46200	13731	219	23
MEAN	85562	1562	1956	47350	13989	224	19

Table 8. Summary of FORMANB short reports, ranked by primary volume harvested for twenty (20) 100-year simulation runs.

SIM NO.	PRIMARY VOLUME HARVEST (1000 m3)	BURN AREA (ha)	PRIMARY GROWING STOCK YEAR 100 (1000 m3)	SECONDARY GROWING STOCK YEAR 100 (1000 m3)	SECONDARY VOLUME HARVEST (1000 m3)	POTENTIAL MORTALITY (1000 m3)	REALIZED MORTALITY (1000 m3)
No-burn	52000	0	2628	1977	15582	176	12
Run 10	46200	103156	678	1698	13731	219	23
Run 18	46600	84768	757	1689	13951	203	21
Run 13	47100	98225	1003	1862	13707	297	17
Run 12	47100	92322	817	1638	13510	195	19
Run 8	47100	91784	200	1884	14142	209	23
Run 19	47100	78699	1006	2738	13307	192	14
Run 20	47100	71122	1884	1932	14447	213	22
Run 7	47200	102045	1146	2136	13913	211	19
Run 15	47300	80964	1359	1907	14381	211	22
Run 11	47400	85495	2730	2156	14076	226	19
Run 17	47400	88838	1598	1947	14014	205	22
Run 16	47400	80750	3679	2143	14010	182	19
Run 1	47400	77563	3637	2295	13861	411	21
Run 14	47500	83018	1261	1928	14056	212	18
Run 2	47500	93066	1119	2293	13948	211	21
Run 4	47800	89162	475	1650	14005	188	16
Run 6	47800	85057	1336	2525	14069	215	20
Run 3	47800	79725	1054	1454	14353	263	22
Run 5	48000	80390	3542	1330	14438	226	10
Run 9	48200	65090	1955	1916	13862	199	18
MEAN	47350	85562	1562	1956	13989	224	19

Table 9. Summary of FORMANB short reports, ranked by primary volume lost for twenty (20) 100-year simulation runs.

SIM NO.	PRIMARY VOLUME LOST  (1000 M3)	BURN AREA  (ha)	PRIMARY GROWING STOCK YEAR 100 (1000 m3)	SECONDARY GROWING STOCK YEAR 100 (1000 m3)	PRIMARY VOLUME HARVEST (1000 m3)	SECONDARY VOLUME HARVEST (1000 m3)	POTENTIAL MORTALITY (1000 m3)	REALIZED MORTALITY (1000 m3)
No-burn	0	0	2628	1977	52000	15582	176	12
Run 14	732	83018	1261	1928	47500	14056	212	18
Run 9	790	65090	1955	1916	48200	13862	199	18
Run 2	825	93066	1119	2293	47500	13948	211	21
Run 11	931	85495	2730	2156	47400	14076	226	19
Run 3	946	79725	1054	1454	47800	14353	263	22
Run 1	966	77563	3637	2295	47400	13861	411	21
Run 6	1076	85057	1336	2525	47800	14069	215	20
Run 7	1129	102045	1146	2136	47200	13913	211	19
Run 4	1138	89162	475	1650	47800	14005	188	16
Run 17	1171	88838	1598	1947	47400	14014	205	22
Run 5	1184	80390	3542	1330	48000	14438	226	10
Run 20	1272	71122	1884	1932	47100	14447	213	22
Run 8	1273	91784	200	1884	47100	14142	209	23
Run 18	1294	84768	757	1689	46600	13951	203	21
Run 15	1384	80964	1359	1907	47300	14381	211	22
Run 12	1399	92322	817	1638	47100	13510	195	19
Run 16	1426	80750	3679	2143	47400	14010	182	19
Run 13	1501	98225	1003	1862	47100	13707	297	17
Run 10	1571	103156	678	1698	46200	13731	219	23
Run 19	1637	78699	1006	2738	47100	13307	192	14
MEAN	1182	85562	1562	1956	47350	13989	224	19



Table 10. Comparison of burn Area and growing stock, ranked by burn area for twenty (20) 100-year simulation runs.

SIM NO.	BURN AREA (ha)	PRIMARY GROWING STOCK (PGS) (1000 m3) YEAR 100	CHANGE PGS FROM YEAR 0 (1000 m3)	SECONDARY GROWING STOCK (SGS) (1000 m3) YEAR 100	CHANGE SGS FROM YEAR 0 (1000 m3)	CHANGE TOTAL GROWING STOCK (1000 m3)
No-burn	0	2628	17083	1977	5601	22717
Run 9	65090	1955	17789	1916	5662	23451
Run 20	71122	1884	17860	1932	5646	23507
Run 1	77563	3637	16107	2295	5283	21390
Run 19	78699	1006	18738	2738	4841	23579
Run 3	79725	1054	18690	1454	6124	24814
Run 5	80390	3542	16202	1330	6248	22450
Run 16	80750	3679	16065	2143	5435	21501
Run 15	80964	1359	18385	1907	5671	24056
Run 14	83018	1261	18483	1928	5650	24133
Run 18	84768	757	18987	1689	5889	24876
Run 6	85057	1336	18408	2525	5053	23460
Run 11	85495	2730	17014	2156	5422	22436
Run 17	88838	1598	18146	1947	5631	23777
Run 4	89162	475	19269	1650	5928	25198
Run 8	91784	200	19545	1884	5694	25239
Run 12	92322	817	18927	1638	5940	24867
Run 2	93066	1119	18625	2293	5285	23910
Run 13	98225	1003	18741	1862	5716	24457
Run 7	102045	1146	18598	2136	5442	24040
Run 10	103156	678	19066	1698	5880	24946
MEAN	85562	1562	18182	1956	5622	23804

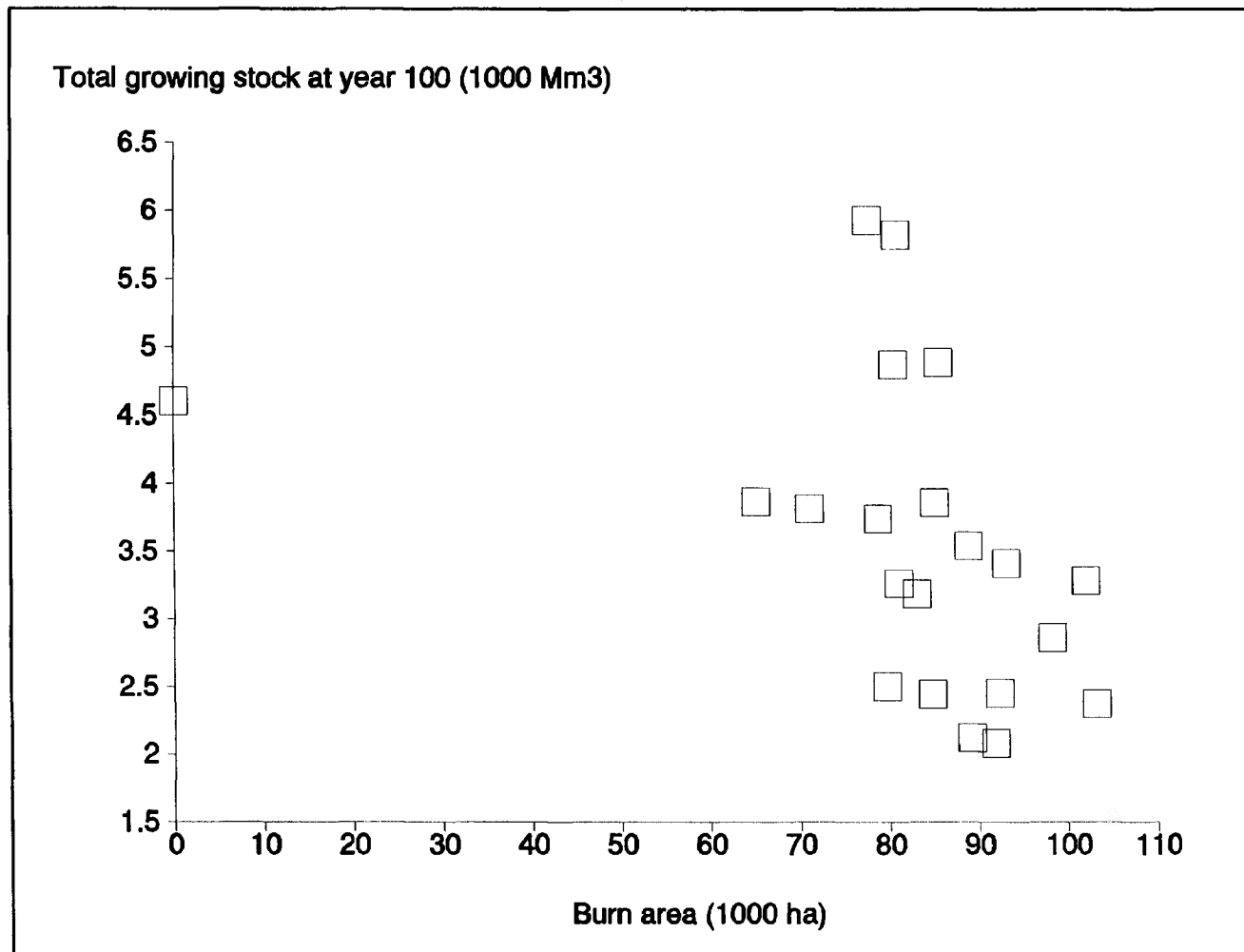

Figure 6. Total growing stock at year 100 vs burn area for twenty (20) 100-year simulation runs.

the residual growing stock over that in the non-burn condition.

Figure 7 is a similar display of the sustainable harvest level and corresponding residual total growing stock at year 100, for each of the 20 simulation runs. A narrow band of harvest levels create a considerable spread in the total growing stock values.

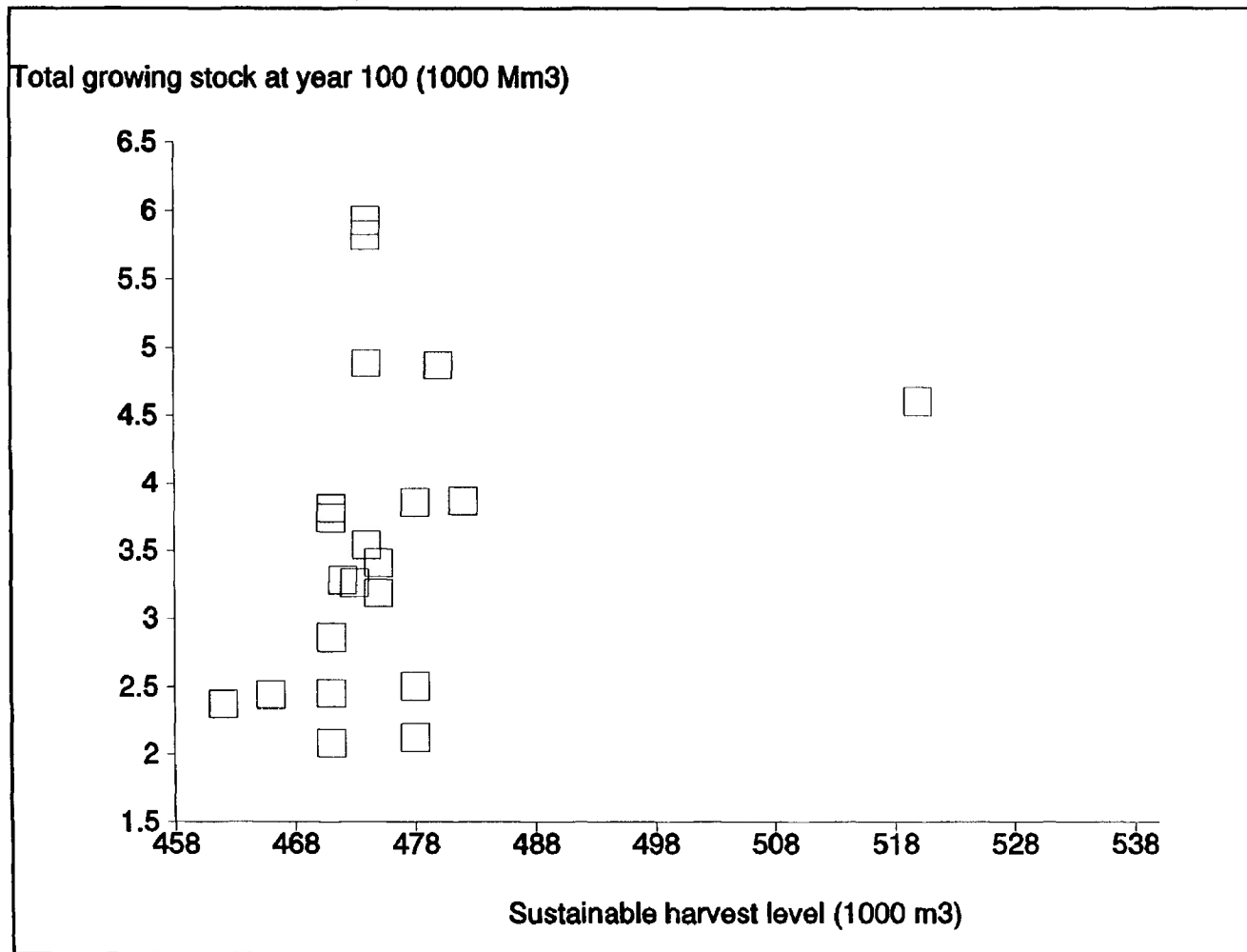

Figure 7. Total growing stock at year 100 vs sustainable harvest level for twenty (20) 100-year simulation runs.

## CHAPTER VI. RESULTS AND DISCUSSION

The incidence of fire lowers the sustainable harvest level by 46,500 m<sup>3</sup> per year, or 9%, on the model of the Nakina Forest simulated here. Lower sustainable harvest levels determined in the presence of risk of fire are consistent with the findings of Reed and Errico (1986).

The average primary volume lost to all fires over the planning horizon is 1,182,000 m<sup>3</sup>, or 2.5 years of harvest. Of the 1,654,000 m<sup>3</sup> of primary volume burned, only 472,000 m<sup>3</sup> (29%) was available for salvage. In contrast, of the 722,000 m<sup>3</sup> of secondary volume burned, 336,000 m<sup>3</sup> (47%) was available for salvage.

The difference can be explained by examining the burn profile of any of the 20 simulation runs. In any fire where both primary and secondary volumes are burned, salvage rates are equal. On other fires where forest classes are burned that have only primary conifer volumes no secondary volumes are burned. The same holds true on fires involving forest classes having only hardwood volumes. When results are summarized over the planning horizon this distinction is not apparent.

The results in this study show no relationship between the amount of area burned and primary or secondary growing

stock at year 100, primary or secondary volumes harvested, and potential or realized mortality (Table 7). This conclusion disagrees with the earlier findings of Martell (1994) who suggested that as the amount of forest area burned increased, the harvest level decreased.

As the primary volume harvested over the planning horizon increased, illustrated by reordering the simulation runs by increasing primary volume harvested, no trends were apparent in the parameters described above (Table 8). Similarly, as primary volume loss over the planning horizon increased no trends were apparent (Table 9).

However, the average primary and secondary volumes harvested for the planning period were lower than the no-burn case. This supports the statement by Reed and Errico (1986) that even low incidence of fire can result in lower harvest levels than those determined in the absence of fire.

The average primary and secondary growing stock at year 100 was lower than the no-burn level. Table 10 further compares the change in growing stock levels over time for each of the 20 runs. While the average primary growing stock at year 100 for the 20 runs is 59% of the no-burn condition, the difference in the net change in primary growing stock between the burn and the no-burn condition is only 6%.

In this study, a sustainable harvest level determined

in the absence of the risk of forest fire seriously reduces the growing stock over time. However, the total growing stock appears to be insensitive to variation in the sustainable harvest level, as illustrated in Figure 7.

The additional decrease in the growing stock as a result of fire is less than might have been expected, i.e. the forest is resilient to forest fire. This would suggest that the long term sustainability of the growing stock is less sensitive to the risk of forest fire than it is to the long term harvest level. Variation in the amount of burn area does not appear to affect the total growing stock at year 100 (Figure 6)

There is a 1% difference in the secondary growing stock levels at year 100 between the no-burn condition and the average burn condition. The net change in secondary growing stock between the no-burn condition and the average burn condition is less than 1%. When the primary and secondary growing stock are combined the net change between the no-burn and average burn condition is 5%.

Potential and realized mortality rates for the 20 simulation runs were higher than the no-burn condition. In the no-burn condition 6.8% of the potential mortality occurred, while in the average burn condition 8.4 % of the potential mortality occurred. Potential mortality is defined by Vanguard Forest Management Services (1993) as the amount of primary volume lost, in an iteration, if no

harvest occurs. The loss is made up of changes in volume for forest classes with negative net growth and residual primary volume of classes that have exceeded their breakup age. Realized mortality is the actual mortality in any iteration.

Lower harvest levels determined in the presence of fire do not capture the actual mortality occurring in the forest. In an attempt to achieve an even flow of wood, opportunities may be lost to utilize higher harvest levels when mortality is expected to be great.

Reed and Errico (1986) suggested that current timber supply projections that do not consider losses due to fire are too high. The results of this case study support this statement. The reduction of the harvest level by 9%, compared to a situation with no fire, may or may not be critical and will depend on the wood supply situation.

#### OPTION EVALUATION

Sustainable harvest levels determined using a simulation model such as FORMAN are a starting point for further analysis. Models, in themselves, do not dictate solutions. Because models are abstractions of reality, the forest manager must temper their use with operational realities to make informed decisions. Ultimately, the forest manager cannot relinquish the responsibility of



making the final decision. All reasonable outcomes should be evaluated and the best course of action taken.

Given the outcomes of the FORMAN-based analyses for the Nakina forest, the forest manager has a number of options. The three options considered in this case are: a regular harvest level that does not incorporate the risk of fire; a fire-adjusted harvest level; or an increased harvest level that attempts to capture potential losses due to fire.

#### Wood Supply Analysis

Given the three options above, the forest manager should evaluate each in a larger timber-supply context. To begin, a thorough and comprehensive examination of the timber-supply situation for the company, short and long-term, is called for. Components of this wood supply analysis might include and are not restricted to:

- i) mill(s) demand;
- ii) anticipated sustainable supply from all sources;  
and
- iii) internal and external threats to timber supply,  
real or anticipated.

Such a wood-supply analysis would address a number of relevant issues and attempt to answer a number of outstanding questions:

1. What is the contribution of fibre from this unit in terms of volume, species, products and costs?
2. Is the harvest level, by forest unit, being totally utilized in this management unit? If harvest levels are currently underutilized, the situation is less critical than if the harvest level is fully utilized or if an aggressive acceleration factor is being implemented.
3. Do mill requirements totally utilize all the species of wood fibre available? The existence of surpluses across the company's license should be evaluated by location and species to determine whether substitutions are possible (e.g. poplar pulp for spruce pulp).
4. Are all species being totally utilized? There may be opportunities to supplement one species requirement with another species not currently used.
5. What other threats exist for the wood supply?
  - i) Possible internal pressures may include: new product manufacturing processes, and more restrictive forest management practices for environmental integrity and ecosystem function.
  - ii) External pressures may include: potential land-base withdrawals, losses of wood for

other forest values, old growth management techniques, and reserves. Tenure issues, escalating land rent and stumpage fees cannot be ignored.

The identification of which issues are critical will depend on the individual processing facility. The effects of these issues on timber supply are cumulative. To consider any of these factors in isolation is ultimately unrealistic. To compound the problem, some effects are easily quantified while others are less tangible and may be impossible to quantify.

The model presented here allows the forest manager to treat the risk of fire explicitly as part of a wood-supply analysis. Its impact can be quantified and directly incorporated into option development and evaluation. This should increase the manager's confidence in the long-term timber supply projections and short-term harvest levels.

### Evaluating Option 1

Option 1, the preferred option to maximize timber production, dictates that the regular harvest level be used on the Nakina forest.

The species and age-class distribution describing the Nakina forest suggest that this management unit is at low forest fire risk. Thirty percent of the forest is in the

lowland spruce forest unit and, other than the spruce forest units, the forest is largely immature or mature.

In choosing this option the forest manager must design the forest management program to ensure that this timber supply remains protected into the future. Even though conclusions of Dempster and Stevens (1987) agree with those previously presented, i.e. quantifying the risk of fire in forest management strategy design leads to lower harvest levels, their recommendations do not support lowering harvest levels. They focused, instead, on risk management techniques to decrease the importance of fire over the long term. A number of mechanisms can be put in place as part of a risk management strategy.

In the 1990 timber management plan for the Nakina forest the MAD landbase is reduced by 5% each period to account for a number of factors, including fire losses. Over the long term, the productive landbase continues to erode. Because the incidence of fire is a problem of volume loss and not area it seems reasonable to discontinue this practice. Instead, the landbase should only be reduced for factors that are area withdrawals e.g. roads and landings. The volume associated with land removed for losses due to fire and insects should be included in the harvest level determination. A re-examination of this practice is justified.

A program of capturing mortality before it occurs may

be effective in reducing volume loss due to fire. Dempster and Stevens (1987) suggested a program of risk-adjusted harvest scheduling to capture potential mortality. In such a system, stands are assessed for potential fire danger. If these stands are eligible for harvest, they are then identified as priorities in harvest scheduling to reduce the probability of loss by fire. Before embarking on such a program, the forest manager must weigh the costs for this type of planning against benefits of assured volume.

A second approach is to rank stands or operating units according to their fire susceptibility or flammability. As suggested in the model presented here, susceptibility can be expressed as a function of species, site and age. Operating units are evaluated on the basis of susceptibility and then ranked on the basis of volume, quality and proximity to the mill. It is reasonable to queue first, those stands for harvest with the most desirable mix of volume and quality, and highest susceptibility. In reality, the most accessible high value stands at highest risk are harvested first. Those less desirable stands of high risk are harvested as encountered, in the course of regular operations. This approach recognizes the risks associated with immature as well as mature and overmature stands.

When the decision is made to adopt the regular harvest level, the need to integrate risk management techniques

into the forest management program for the unit gains more importance. Present risk management systems need to be reviewed, and if necessary, expanded. Dempster and Stevens (1987) supported this and found that even a small reduction in fire rates lead to a large benefit in expected yield.

Present methods of risk protection may be consistent with the amount of money a company wants to invest in an insurance policy against risk. Assigning a dollar value to risk management may be difficult. An intangible value may be hard to justify in a proposed budget, but in a critical wood supply situation, the losses that may result if investments are not made may be more difficult to explain.

Consider a hypothetical example: company X has a large Crown timber license in the boreal forest dominated by mature jack pine, largely unmanaged and not accessed. A catastrophic fire destroys most of the standing inventory on the area. Assuming salvage volumes are minimal, the long-term supply no longer exists.

There are measures that can be taken that may reduce the risk of a fire occurring. The unit could be road accessed, the harvest could be scheduled so that stands of high risk are harvested first. This may increase harvest costs, especially if high risk stands are at a greater distance from the mill than current operations. Additional costs associated with either of these measures may not be justifiable today to ensure that timber volumes exist in

the future.

Assume that the fire takes place. The costs of salvage, site preparation, planting and tending may not be balanced with the revenue from the standing timber. As a result, a reasonable investment in risk management may become justifiable. Effective fire protection programs are essential when the forest is at high fire risk and the live timber is badly needed.

### Evaluating Option 2

The forest manager may choose option 2 and prescribe the fire-adjusted harvest level for the forest. Age-class and species distributions may indicate a forest highly susceptible to fire. Historical forest fire history, i.e. regular and high occurrence, may suggest that the forest fire regime overrides the effect of any management measures on the forest. A forest may be so flammable that even regular protection measures cannot prevent it from being regularly burned. Choosing a fire-adjusted harvest level on such a forest seems reasonable to avoid over harvesting.

How does a lower sustainable harvest level in this unit affect the flow of fibre (species and products) to the mill? The long fibre supply from this unit should be evaluated as part of the overall timber supply. If the wood supply pressure on the forest is heavy, and overall

supplies are tight, the manager may feel it appropriate to prescribe a conservative harvest level. This decision must be made with full realization of the impacts on wood flow to the mill, especially if the near-term supply from the unit is critical.

If on the other hand, the supply from this unit is not critical, the forest manager may also recommend a lower sustainable harvest level from this unit. If the volume from this unit is surplus or if the harvest level has not historically been fully utilized, the reduction may have no effect on a large scale.

It may be possible that reductions in this unit can be easily filled from other company units, over either the short or long terms. The forest manager has the option to implement a lower harvest level for the current five years period, evaluate the strategy in five years, and readjust if necessary.

Alternative supplies of timber outside of company license areas should be investigated. Opportunities may exist from other Crown sources. Surpluses may exist or exchanges may be possible with mills that do not utilize all species or products. Open markets may exist to purchase fibre from within Ontario, other provinces or internationally.



### Evaluating Option 3

The third option increases the harvest level to some level in excess of the regular harvest level. If a near-term loss of volume is expected as a result of fire, the intent is to accelerate harvesting to capture the potential mortality. This practice may be justifiable in the short term but may prove unsustainable over the long term. As part of the harvest level determination process in this case study, increasingly higher levels were tested and found to be unsustainable over the planning horizon.

The FORMANB model used in this case study simulated a number of different futures. The results show that primary salvage volumes vary over a wide range. To base a harvesting regime on an assumption of regularity or predictability of salvage harvest levels is unwise.

### FUTURE CONSTRAINTS VS PRESENT REALITIES

Timber losses due to fire are stochastic. There are so many uncertainties that influence the future that it seems unreasonable to constrain the present based on one possible future. Dempster and Stevens (1987) reemphasized that the forest is constantly changing and subject to fluctuations in growth, landbase changes and improvements in forest management techniques. In Ontario, tenure

arrangements and silviculture funding fluctuations and changing responsibilities certainly will affect the future. Dempster and Stevens (1987) stressed that forest managers should not constrain long-term harvest levels by current harvest levels. Instead, they suggest short planning periods and flexible constraints on harvest levels.

#### LIMITATIONS OF FIRE DATA

Historical forest fire patterns used to predict future behaviour may be reflective of a time when forest protection policies are different than they are today, so their use is limited.

The results here are based on one management unit that is a portion of a larger wood supply basin. Applying a forest fire regime based on a large forested area to a small unit will have more impact than it would on a larger unit. The forest fire regime should be applied to the same size of area from which the data were collected. Dempster and Stevens (1987) suggested that forested areas with similar forest fire history be stratified into fire ecology regions.

## FORESTRY INVESTMENT

The right to current and future harvests of timber is known as tenure. The future harvest volume is the growing stock. Lending institutions want to invest only in good risks and the forest industry wants low uncertainty in its wood supply. Investments like mill diversification that depend on timber supply should consider the risk connected to wood supply (Dempster and Stevens, 1987). The ability to quantify risk is a step toward including them into the evaluation of investment options.

## FURTHER RESEARCH AND APPLICATIONS

The model developed here has been demonstrated using one data set. The model should be thoroughly evaluated on other forests subject to different fire regimes. It may be that a forest insensitive to forest fire may justify higher harvest levels than currently used. On the other hand, a forest with short forest fire intervals may currently be over harvested.

Determining a acceptable range of harvest levels from period to period may be effective in capturing mortality actually occurring in the forest.

With an increasing emphasis to ensure the right product arrives at the appropriate mill, it would be useful

to study the effect of forest fire on product volumes, in addition to total volumes. A sawmill may find out that its product mix is more sensitive to fire than the total volume of fibre.

In the current version of FORMANB.FOR total volume losses are calculated. It would be useful to track the volume lost and salvage potential by fire type i.e. by gentle, medium intensity and catastrophic fires.

A reasonable step would be to link the FORMANB model to a geographic information system (GIS). Some of the cost associated with risk management investment options could be evaluated with spatial detail. Incorporating BURN into an existing wood supply model with GIS capabilities would maintain the spatial integrity of the individual fires and aid in evaluating the feasibility of salvage operations.

## REFERENCES

- Baskerville, G.L. 1986. The State of Forest Research in Canada. Paper presented at University of Toronto lecture November 7, 1986. Toronto. 33 pp. (Mimeographed).
- Boychuk, D. and D.L. Martell. 1993. Forest Management Under Uncertainty: A Fire Management Perspective pp. 72-85 in Davis, R. (ed.) Proc. Symp. Analytical Approaches to Resource Management, Sault Ste. Marie, Ontario, Nov. 24-26, 1992. 177 pp.
- Caza C. 1994. Information Needs for the Protection of Non-Timber Values in Forest Planning pp. 40-45 in Kayll, A.J. (ed.) Proc. Symp. Forest Planning: The Leading Edge, North Bay, Ontario, Oct. 30-31, 1991. 169 pp.
- Davis, R. 1993. Analyzing Ontario's Timber Supply with the Strategic Forest Management Model pp. 52-71 in Davis, R. (ed.) Proc. Symp. Analytical Approaches to Resource Management, Sault Ste. Marie, Ontario, Nov. 24-26, 1992. 177 pp.
- Davis, R. 1994a. Strategic Forest Management Model: A User's Guide - Draft. Unpublished, Ont.Min.Nat.Res., Sault Ste. Marie, Ontario.
- Davis, R. 1994b. Personal Communication.
- Davis, R. 1994c. The Strategic Forest Management Model - SFMM. Unpublished, Ont.Min.Nat.Res., Sault Ste. Marie, Ontario.
- Dempster, W.R. and N.A. Stevens. 1987. Risk management in forest planning. Can.For.Serv., Edmonton, Alberta, 48 pp.
- Duinker, P.N. 1994. On Setting Goals in Forest Resources Management. pp. 1-8 in Kayll, A.J. (ed.) Proc. Symp. Forest Planning: The Leading Edge, North Bay, Ontario, Oct 30-31, 1991. 169 pp.
- Fight, R.D. and E.F. Bell. 1977. Coping with uncertainty -a conceptual approach for timber management planning. USDA For.Serv.Gen.Tech.Rep. PNW-59, Pac. Northwest. For. and Range Exp. Stn., Portland, Oregon 18 pp.
- Forbes, R. 1988. Personal Correspondence.

- Forbes, R. 1990. 1990-2010 Timber Management Plan for the Nakina Forest. Unpublished, Kimberly Clark, Longlac, Ontario.
- Jamnick, M.S. 1990. A comparison of FORMAN and linear programming approaches to timber harvest scheduling. *Can.J.For.Res.* 20:1351-1360.
- Johnson, K.N., Stuart, T.W., and Crim, S.A. 1986. FORPLAN Version 2: an overview. Land Management Planning Systems Section, USDA For.Serv., Washington, D.C.
- Kleijnen, J.P.C. 1974. Statistical Techniques in Simulation. Part 1. Marcel Dekker Inc. New York, New York. 285 pp.
- Kloss, D. and J. Oatway. 1992. Users Guide for MADCALC version 5.0.0. Unpublished, Ont.Min.Nat.Res., Sault Ste. Marie, Ontario. 71 pp.
- Lougheed, W.H. 1988. Spatial analysis in timber management planning. M.Sc. thesis. Lakehead Univ., Thunder Bay, Ont.
- Marshall, P.L. 1986. A decision context for timber supply modelling. *For.Chron.* 62(6): 533-536.
- Martell, D.L. 1980. The optimal rotation of a flammable forest stand. *Can J.For.Res.* 10:30-34.
- Martell, D.L. 1994. Potential Applications of Mathematical Programming to Forest Management Planning in Ontario. pp.60-66 in Kayll, A.J. (ed.) Proc. Symp. Forest Planning: The Leading Edge, North Bay, Ontario, Oct. 30-31, 1991. 169 pp.
- Moore, T. 1994. Landscapes of the Future: Interpretation of Wood Supply Projections. pp.46-53 in Kayll, A.J. (ed.) Proc. Symp. Forest Planning: The Leading Edge, North Bay, Ontario, Oct. 30-31, 1991. 169 pp.
- Moore, T.G.E. and C.G. Lockwood. 1990. The HSG Wood Supply Model: Description and User's Manual. For. Can.Inf.Rep.PI-X-98. Chalk River, Ontario, 31 pp.
- Morton, R.T. 1990. A Modeling Primer. pp. 18-20 in Broughton, B.J. and J.K. Samoil (ed.) Proc. Symp. Forest Modeling Symposium, Saskatoon, Saskatchewan, March 13-15, 1989. For.Can.Inf.Rep. NOR-X-308. 180 pp.

- Navon, D.I. 1971. TimberRAM...A long-range planning method for commercial timber lands under multiple-use management. USDA For. Serv. Res. Pap. PSW-70, Pacific Southwest Forest and Range Experiment Station, Berkeley, CA. 22 pp.
- Newbold, P. 1986. Principles of Management Science. Prentice-Hall, Inc., Englewood Cliffs, New Jersey. 704 pp.
- Newnham, R.M. 1987. FIRFOR - A simple forest management model. Info. Rep. PI-X-72. Chalk River, Ontario. 94 pp.
- Ontario Ministry of Natural Resources. 1986. Timber Management Planning Manual for Crown Lands in Ontario. Queen's Printer for Ontario, Toronto, Ontario. 218 pp.
- Reed, W.J. and D. Errico. 1985a. Assessing the long-run yield of a forest stand subject to the risk of fire. Can.J.For.Res. 15:680-687.
- Reed, W.J. and D. Errico. 1985b. Optimal Harvest Scheduling at the forest-level in the presence of risk of fire. Information Report 85-3. Forest Economics and Policy Analysis Project. University of British Columbia. Vancouver, British Columbia. 47 pp.
- Reed, W.J. and D. Errico. 1986. Optimal harvesting at the forest level in the presence of the risk of fire. Can J. For. Res. 16:266-278.
- Reed, W.J. and D. Errico. 1989. Harvest Scheduling in the Presence of the Risk of Fire - Further Results. Working Paper 120. Forest Economics and Policy Analysis Research Unit. University of British Columbia. Vancouver, British Columbia.
- Roussell, T.G., Wang, E.C., and T.A. Erdle. 1991. FORMAN+1 Forest Development Simulation Model for Even-Aged Management - User manual Version 2.0, Vanguard Forest Management Services Ltd., Fredericton, New Brunswick. Unpublished.
- Routledge, R.D. 1980. The Effect of Potential Catastrophic Mortality and other Unpredictable Events on Optimal Forest Rotation Policy. For.Sci. 26(3): 389-399.
- Rubinstein, R.Y. 1981. Simulation and the Monte Carlo Method. John Wiley and Sons, New York. 256 pp.

- Thompson, E.F. 1968. The theory of Decision Under Uncertainty and Possible Application in Forest Management. For.Sci. 14(2):156-163.
- Vanguard Forest Management Services Ltd. 1993. FORMAN+2 Wood Supply Model User Manual, Fredericton, New Brunswick, Unpublished.
- Walker, H.D. 1987. Modelling Forest Management pp. 96-101 in Primeval Improvement: The New Forestry Age. COJFRC Symp. Proc. 0-P-15, Thunder Bay, Ontario, Oct. 21-23, 1986. 134 pp.
- Van Wagner, C.E. 1978. Age-class distribution and the forest fire cycle. Can.J.For.Res 8:220-227.
- Van Wagner, C.E. 1983. Simulating the effect of forest fire on long-term annual timber supply. Can.J.For. Res. 13:451-457.
- Wang, E.C., T.A. Erdle, and T.G. Roussell. 1987. FORMAN wood supply model - User manual. N.B. Executive Forest Research Committee Inc., Fredericton, New Brunswick. Unpublished.
- Willcocks, A.J. and R. Watt. 1994. Crop Planning: A Component of Sustainable Forestry pp. 9-14 in Kayll, A.J. (ed.) Proc. Symp. Forest Planning: The Leading Edge, North Bay, Ontario, Oct. 30-31, 1991. 169 pp.
- Willcocks, A.J., F.W. Bell, J. Williams and P.N. Duinker. 1990. A crop-planning process for northern Ontario forests. NWOFTDU Technical Report #30. Thunder Bay, Ontario 159 pp.
- Williams, J. 1991. Crop planning manual for northern Ontario. NWOFTDU Technical Report #65. Thunder Bay, Ontario 110 pp.



APPENDICES

APPENDIX A

APPENDIX A-1

CALL statement in FORMANB to invoke subroutine BURN

```

*****
C   *START ITERATIONS*
*****
C
      DO 620 IIT=1,NIT
C
      CALL BURN( ID,AREAS,AGES,IYCPR,IYCFU,IYCPL,
*   PLPR,CROWN,MANAG,OPVOLP,OPVOLS,PRVOL,
*   NCLAS,IIT,NIT,NEXT)
C
*****
C   *INITIALIZE*
*****
C
      DO 450 I=1,10
      ACS(IIT,I) = 0
450  CONTINUE
      PLANT = PLANTO(IIT)

```

APPENDIX A-2  
Subprogram BURN.FOR

## SUBPROGRAM BURN.FOR

BURN.FOR WAS DEVELOPED BY V. BALL, JANUARY 1993.

FORMAN VERSION 2.1 WAS WRITTEN BY E. WANG, T. ERDLE AND T. ROUSSELL IN 1987. THE SUBPROGRAM BURN SIMULATES THE RISK OF FOREST FIRE. FORMANB.FOR IS A MODIFIED VERSION OF FORMAN THAT INCORPORATES THE SUBPROGRAM BURN. A SIMPLE CALL STATEMENT IN FORMANB INVOKES BURN EACH TIME THE MODEL IS RUN.

BURN IS THE SHELL FROM WHICH A NUMBER OF SUBPROGRAMS ARE CALLED TO PERFORM DIFFERENT TASKS IN THE SIMULATION.

BURN IS WRITTEN IN MICROSOFT FORTRAN THAT CONFORMS TO FORTRAN 77. THE ALGORITHM WAS COMPILED USING THE MICROSOFT FORTRAN OPTIMIZING COMPILER, VERSION 4.0.

\*\*\*\*\*

SUBROUTINE BURN(IDF,AREAF,AGEF,YCPR,YCFU,YCPL,PLP,  
OWN,MAN,OVOLP,OVOLS,PVOL,NCLASS,TIME,LTIME,NCL)  
PARAMETER(LIM=800)

## VARIABLES

IDF(I): FOREST CLASS IDENTIFICATION  
 AREAF(I): FOREST CLASS AREA  
 AGEF(I): FOREST CLASS AGE  
 YCPR(I): PRESENT CURVE SET  
 YCFU(I): FUTURE CURVE SET  
 YCPL(I): INTENSIVE SILVICULTURE TREATMENT CURVE SET  
 PLP(I): PLANTING PRIORITY  
 OWN: OWNERSHIP  
 MAN(I): MANAGEMENT UNIT  
 OPVOLP(I): OPERABLE VOLUME-PRIMARY  
 OPVOLS(I): OPERABLE VOLUME-SECONDARY  
 PVOL(I): PRODUCT VOLUME  
 NCLASS: NUMBER OF FOREST CLASSES  
 TIME: ITERATION NUMBER  
 LTIME: NUMBER OF ITERATIONS  
 NCL: COUNTER FOR NUMBER OF NEW FOREST CLASSES  
 I,J,K: COUNTERS  
 RTIME: TIME IN YEARS  
 START: NUMBER OF FIRE STARTS  
 TFOR: TOTAL FOREST AREA  
 BRNA: BURN AREA IN AN ITERATION  
 TBRNA: TOTAL BURN AREA  
 NFC: NUMBER OF FOREST CLASSES  
 TSTAR: TOTAL NUMBER OF STARTS  
 FCD(I): AREA DISTRIBUTION OF FOREST CLASSES  
 BRNP: VOLUME BURNED-PRIMARY IN AN ITERATION  
 BRNS: VOLUME BURNED-SECONDARY IN AN ITERATION  
 BRNPR: VOLUME BURNED-PRODUCT IN AN ITERATION  
 VLP: VOLUME LOSS-PRIMARY IN AN ITERATION  
 VLS: VOLUME LOSS-SECONDARY IN AN ITERATION  
 VLPR: VOLUME LOSS-PRODUCT IN AN ITERATION  
 TBRNP: TOTAL VOLUME BURNED-PRIMARY  
 TBRNS: TOTAL VOLUME BURNED-SECONDARY  
 TBRNPR: TOTAL VOLUME BURNED-PRODUCT  
 TVLP: TOTAL VOLUME LOSS-PRIMARY

```

C          TVLS:          TOTAL VOLUME LOSS-SECONDARY
C          TVLPR:         TOTAL VOLUME LOSS-PRODUCT

C  STORAGE ALLOCATION

      INTEGER*2 IDF(1:LIM),AGEF(1:LIM),YCPR(1:LIM)
      INTEGER*2 YCFU(1:LIM),YCPL(1:LIM),PLP(1:LIM),OWN
      INTEGER*2 MAN(1:LIM),I,TIME,RTIME,LTIME,J,K
      INTEGER*4 AREAF(1:LIM)
      INTEGER*4 NCLASS,START,TFOR,BRNA,TBRNA,NFC,TSTAR,NCL
      REAL OVOLP(1:LIM),OVOLS(1:LIM),PVOL(1:LIM),FCD(1:LIM)
      REAL BRNP,BRNS,BRNPR,VLP,VLS,VLPR,TBRNP,TBRNS,TBRNPR
      REAL TVLP,TVLS,TVLPR

C  ENSURE THAT ITERATION TOTALS ARE SAVED

      SAVE TBRNA,TBRNP,TBRNS,TBRNPR,TVLP,TVLS,TVLPR

C  OPEN I/O UNITS

      OPEN(8,FILE='TOT.OUT')
      OPEN(9,FILE='BURN.OUT')

C  INITIALIZE VARIABLES

      IF(TIME .EQ. 1) THEN
      WRITE(8,1003)
      TBRNA=0
      TSTAR=0
      TBRNP=0.0
      TBRNS=0.0
      TBRNPR=0.0
      TVLP=0.0
      TVLS=0.0
      TVLPR=0.0
      ENDIF

C  SET UP FOREST CLASS AREA DISTRIBUTION

      CALL SETUP(NCLASS,AREAF,TFOR,FCD)
      NFC=NCLASS

C  DETERMINE NUMBER OF FIRE STARTS

      START=NOSTART()
      IF(START .EQ. 0) THEN
      WRITE(9,1004) TIME*5
      GO TO 10
      ENDIF

C  ASSIGN FIRE START TO A FOREST CLASS

      CALL ASSIGN(NCLASS,START,TFOR,FCD,IDF,AREAF,AGEF,
*      YCPR,YCFU,YCPL,PLP,OWN,MAN,OVOLP,OVOLS,PVOL,
*      BRNP,BRNS,BRNPR,VLP,VLS,VLPR,BRNA,NFC,TIME,NCL)

```

C GET RID OF EMPTY FOREST CLASSES

```

      DO 4 J=1,NCLASS
        DO 5 K=J+1,NCLASS
          IF ((AGEF(J) .EQ. AGEF(K)) .AND.
*          (YCPR(J) .EQ. YCPR(K)) .AND.
*          (YCFU(J) .EQ. YCFU(K)) .AND.
*          (YCPL(J) .EQ. YCPL(K)) .AND.
*          (PLP(J) .EQ. PLP(K)) .AND.
*          (MAN(J) .EQ. MAN(K))) THEN
            AREAF(J) = AREAF(J) + AREAF(K)
            AREAF(K)=0
          ENDIF
        5 CONTINUE
      4 CONTINUE

```

C PRINT ITERATION RESULTS

```

RTIME=TIME*5
WRITE(8,1000)RTIME,START,BRNA,BRNP,BRNS,BRNPR,VLP,VLS,VLPR

```

C TOTAL BURN STATISTICS OVER PLANNING HORIZON

```

TBRNA=TBRNA+BRNA
TSTAR=TSTAR+START
TBRNP=TBRNP+BRNP
TBRNS=TBRNS+BRNS
TBRNPR=TBRNPR+BRNPR
TVLP=TVLP+VLP
TVLS=TVLS+VLS
TVLPR=TVLPR+VLPR
10 CONTINUE

```

C PRINT TOTALS FOR THE PLANNING HORIZON

```

IF(TIME .GE. LTIME)THEN
WRITE(8,1001)TSTAR,TBRNA,TBRNP,TBRNS,TBRNPR,TVLP,TVLS,TVLPR
ENDIF

```

C FORMAT REPORTS

```

1000 FORMAT(I4,I6,I6,F11.2,F11.2,F11.2,F11.2,F11.2,F11.2)
1001 FORMAT(// 'TOTAL' ,1X,I4,I6,F11.2,F11.2,F11.2,F11.2,
* F11.2,F11.2)
1002 FORMAT(I3,I8,I3,I3,I3,I3,I2,I3,I3,F11.2,F11.2,F11.2)
1003 FORMAT('SUMMARY BURN PROFILE'// 'TIME' ,2X,'STARTS'
* 1X,'BURN' ,2X,'PRIMARY' ,4X,'SECONDARY' ,3X,'PRODUCT' ,
* 4X,'SALVAGE' ,4X,'SALVAGE' ,4X,'SALVAGE' /13X,'AREA' ,
* 1X,'VOL BURNED' ,
* 1X,'VOL BURNED' ,1X,'VOL BURNED' ,2X,'PRIM VOL' ,4X,
* 'SEC VOL' ,3X,'PROD VOL' //)
1004 FORMAT('THERE ARE NO FIRES IN YEAR ' ,I4//)
RETURN
END

```



APPENDIX A-3  
Subprogram SETUP.FOR

```

C                               SUBPROGRAM SETUP.FOR
C
C   SETUP DETERMINES THE AREA DISTRIBUTION OF THE FOREST
C   CLASSES AT THE BEGINNING OF EACH ITERATION
C
C   SUBROUTINE SETUP(NCLASS,FCAREA,TOT,TRIB)
C
C   VARIABLES
C
C   NCLASS:      NUMBER OF FOREST CLASSES
C   FCAREA(I):   FOREST CLASS AREA
C   TOT:         TOTAL AREA OF THE FOREST
C   TRIB(I):     AREA DISTRIBUTION OF FOREST CLASSES
C   PERCENT(I):  FCAREA/TOT
C
C   STORAGE ALLOCATION
C
C   PARAMETER(LIM=800)
C   INTEGER*2 NCLASS
C   INTEGER*4 FCAREA(1:LIM)
C   INTEGER*4 TOT
C   REAL TRIB(1:LIM),PERCENT(1:LIM)
C
C   ADD UP AREA IN FOREST CLASSES
C
C   TOT=0
C   DO 1 I=1,NCLASS
C   TOT=TOT + FCAREA(I)
1  CONTINUE
C
C   SET UP AREA DISTRIBUTION
C
C   TRIB(0)=0
C   DO 2 I=1,NCLASS
C   PERCENT(I)=FCAREA(I)/REAL(TOT)
C   TRIB(I)=TRIB(I-1) + PERCENT(I)
2  CONTINUE
C
C   IF (TRIB(NCLASS) .LT. 1.0)TRIB(NCLASS)=1.0
C
C   RETURN
C   END

```

APPENDIX A-4

Subprogram NOSTART.FOR

```

C                               SUBPROGRAM NOSTART.FOR
C
C   NOSTART DETERMINES THE NUMBER OF STARTS IN EACH
C   ITERATION ACCORDING TO HISTORICAL FOREST FIRE PATTERNS
C
C   INTEGER FUNCTION NOSTART()
C
C   VARIABLES
C   START(I) :      FOREST FIRE STARTS DISTRIBUTION
C   UPPER(I) :      FOREST FIRE STARTS PROBABILITY DISTRIBUTION
C   MONTE(I,J,K) :  MONTE CARLO ALGORITHM
C
C   STORAGE ALLOCATION
C
C   INTEGER*2 START(1:22)
C   INTEGER MONTE
C
C   EXTERNAL MONTE
C
C   REAL UPPER(1:22)
C
C   DATA SPECIFICATION
C
C   DATA UPPER/.0313,.0625,.1250,.1875,.2813,.3438,.3750,.4375,
*   .4688,.5000,.5313,.6250,.6563,.7500,.7813,.8125,.8438,.8750,
*   .9063,.9375,.9688,1.0000/
C
C   DATA START/3,5,6,7,8,9,10,11,12,13,14,15,18,20,21,24,26,
*   30,34,43,46,63/
C
C   DETERMINE NUMBER OF STARTS FOR THIS ITERATION
C
C   NOSTART=MONTE(32,UPPER,START)
C
2  CONTINUE
   RETURN
   END

```

APPENDIX A-5  
Subprogram AREA.FOR

```

C                               SUBPROGRAM AREA.FOR
C
C   AREA DETERMINES THE AREA OF EACH FIRE START
C   ACCORDING TO HISTORICAL FOREST FIRE PATTERNS
C
C   INTEGER FUNCTION AREA()
C
C   VARIABLES
C   STAREA(I):          FOREST FIRE AREA DISTRIBUTION
C   RDAREA(I):         FOREST FIRE AREA PROBABILITY DISTRIBUTION
C   MONTE(I,J,K):      MONTE CARLO ALGORITHM
C
C   STORAGE ALLOCATION
C
C   INTEGER*2 STAREA(1:28)
C   INTEGER MONTE
C   REAL RDAREA(1:28)
C
C   EXTERNAL MONTE
C
C   DATA SPECIFICATION
C
C   DATA RDAREA/.1212,.1515,.2121,.2727,.3030,.3333,.3636,.3939,
*   .4242,.4545,.4848,.5151,.5454,.5757,.6060,.6363,.6666,.6969,
*   .7272,.7575,.7878,.8181,.8484,.8787,.9090,.9393,.9693,1.0000/
C
C   DATA STAREA/1,2,3,4,5,11,20,31,32,34,41,46,58,66,82,87,89,120,
*   184,241,284,416,505,525,684,1323,1651,2629/
C
C   DETERMINE AREA IN THE FIRE START
C
C   AREA=MONTE(33,RDAREA,STAREA)
C   RETURN
C   END

```

APPENDIX A-6  
Subprogram MONTE.FOR

```

C                               SUBPROGRAM MONTE.FOR

C   MONTE IS A MONTE CARLO SIMULATION PROGRAM THAT
C   USES A RANDOM NUMBER GENERATOR TO SIMULATE RANDOM
C   OCCURRENCES OF AN EVENT

      INTEGER FUNCTION MONTE(N,FIRST,SECOND)

C   VARIABLES

C   N:           NUMBER OF ITEMS IN THE DISTRIBUTION
C   FIRST(I):   FIRST DISTRIBUTION OF NUMBERS
C   SECOND(I):  SECOND DISTRIBUTION OF NUMBERS
C   I:          COUNTER
C   POINT:      POINTER IN THE SECOND DISTRIBUTION
C   START:      POSITION WHERE SEARCH BEGINS
C   NUM:        RANDOM NUMBER
C   RAN():      RANDOM NUMBER GENERATOR ALGORITHM
C   IRAND():    NUMERICAL SEED ALGORITHM
C   NUMBER:     REAL VALUE OF NUM

C   STORAGE ALLOCATION

      INTEGER*2 SECOND(1:N),I,POINT
      INTEGER*4 N,START,NUM,RAN,IRAND
      REAL FIRST(1:N),NUMBER
      EXTERNAL RAN,IRAND

C   INITIALIZE VARIABLES

      NUM=0
      NUMBER=0
      POINT=0
      FIRST(0)=0

C   DETERMINE A RANDOM NUMBER

      NUM=RAN()

C   SEARCH FIRST DISTRIBUTION FOR RANDOM NUMBER AND USE POINTER TO
C   DETERMINE CORRESPONDING VALUE IN THE SECOND DISTRIBUTION

      NUMBER=REAL(NUM)/10000
      START = N/2
      IF (NUMBER .GT. FIRST(START))THEN

          DO 4 I=START+1,N
              IF (NUMBER .LE. FIRST(I))THEN
                  POINT=I
                  GO TO 5
              ENDIF
          4 CONTINUE
      ELSE
          DO 7 I=START-1,0,-1
              IF (NUMBER .GE. FIRST(I))THEN
                  POINT = I+1
                  GO TO 5
              ENDIF
          7 CONTINUE
      ENDIF

```



```
7         CONTINUE
        ENDIF
5     CONTINUE
C     VALUE IN THE SECOND DISTRIBUTION IS ASSIGNED TO MONTE
        MONTE=SECOND(POINT)
        RETURN
        END
```

APPENDIX A-7  
Subprogram RAN.FOR

```

C          SUBPROGRAM RAN.FOR
C
C  RAN IS A RANDOM NUMBER GENERATOR
C
C  INTEGER FUNCTION RAN()
C
C  VARIABLES
C
C     ISEED:      NUMERICAL SEED
C     IRAND:      NUMERICAL SEED ALGORITHM
C     FIRST:      LOGICAL SEED
C
C     INTEGER ISEED,IRAND
C     LOGICAL FIRST
C
C     EXTERNAL IRAND
C     INTRINSIC ABS
C
C  ENSURE THAT VALUES ARE SAVED
C
C     SAVE FIRST, ISEED
C
C  DATA SPECIFICATION
C
C     DATA FIRST/.TRUE./
C
C     IF (FIRST) THEN
C     WRITE (*,'(1X,A)')
C     'PLEASE ENTER A POSITIVE - NUMBER SEED:'
C     READ*, ISEED
C     ISEED=ABS( ISEED)
C     FIRST=.FALSE.
C     ENDIF
C
C     ISEED=IRAND( ISEED)
C     RAN=ISEED/10000
C     RETURN
C     END
C
C  INTEGER FUNCTION IRAND( ISEED)
C
C  INTEGER ISEED
C  INTEGER ISEED1, ISEED2, M1, M2, MULT1, MULT2, I
C  PARAMETER (MULT1=3141, MULT2=5821)
C  PARAMETER (M1=100000000, M2=10000)
C
C  INTRINSIC MOD
C  ISEED1= ISEED/M2
C  ISEED2=MOD( ISEED, M2)
C  I=MOD( ( (MOD( ( ISEED2*MULT1 + ISEED1*MULT2), M2)
C  M2)+( ISEED2*MULT2)), M1)
C
C  IRAND=MOD( (i+1), M1)
C  RETURN
C  END

```

APPENDIX A-8  
Subprogram ASSIGN.FOR

```

C                               SUBPROGRAM ASSIGN.FOR

C   ASSIGN ALLOCATES FIRE STARTS TO FOREST CLASSES PROPORTIONATE
C   TO THE SIZE OF FOREST CLASS

SUBROUTINE ASSIGN(NCLASS,START,TAREA,ALOCAT,IDF,AREAF,AGE,
*   YCPR,YCFU,YCPL,PLP,OWN,MAN,OVOLP,OVOLS,PVOL,BRNP,BRNS,BRNPR,
*   VLP,VLS,VLPR,BRNA,NFC,TIME,NCL)

PARAMETER(LIM=800)

C   VARIABLES

C   NCLASS:    NUMBER OF FOREST CLASSES
C   START:     NUMBER OF FIRE STARTS
C   TAREA:     TOTAL FOREST AREA
C   ALOCAT(I): AREA DISTRIBUTION OF FOREST CLASSES
C   IDF(I):    FOREST CLASS IDENTIFICATION
C   AREAF(I):  FOREST CLASS AREA
C   AGE(I):    FOREST CLASS AGE
C   YCPR(I):   PRESENT CURVE SET
C   YCFU(I):   FUTURE CURVE SET
C   YCPL(I):   INTENSIVE SILVICULTURE TREATMENT CURVE SET
C   PLP(I):    PLANTING PRIORITY
C   OWN:       OWNERSHIP
C   MAN(I):    MANAGEMENT UNIT
C   OVOLP(I):  OPERABLE VOLUME-PRIMARY
C   OVOLS(I):  OPERABLE VOLUME-SECONDARY
C   PVOL(I):   PRODUCT VOLUME
C   BRNP:      VOLUME BURNED-PRIMARY IN AN ITERATION
C   BRNS:      VOLUME BURNED-SECONDARY IN AN ITERATION
C   BRNPR:     VOLUME BURNED-PRODUCT IN AN ITERATION
C   VLP:       VOLUME LOSS-PRIMARY IN AN ITERATION
C   VLS:       VOLUME LOSS-SECONDARY IN AN ITERATION
C   VLPR:      VOLUME LOSS-PRODUCT IN AN ITERATION
C   BRNA:      BURN AREA IN AN ITERATION
C   NFC:       NUMBER OF FOREST CLASSES
C   TIME:      ITERATION NUMBER
C   NCL:       COUNTER FOR NUMBER OF NEW FOREST CLASSES
C   FC:        FOREST CLASS ID
C   RTIME:     TIME IN YEARS
C   I,J:       COUNTERS
C   BAREA:     BURN AREA
C   AREA:      FIRE AREA ALGORITHM
C   MONTE:     MONTE CARLO ALGORITHM
C   FLAM:      FLAMMABILITY ALGORITHM
C   R:         TEMPORARY STORAGE VARIABLE
C   FCB:       AREA IN NEW FOREST CLASS
C   RISK:      REAL VALUE OF R
C   VLBRNP:   COUNTER FOR VOLUME BURNED-PRIMARY
C   VLBRNS:   COUNTER FOR VOLUME BURNED-SECONDARY
C   PVLBRN:   COUNTER FOR VOLUME BURNED-PRODUCT
C   VLSALP:   COUNTER FOR VOLUME SALVAGED-PRIMARY
C   VLSALS:   COUNTER FOR VOLUME SALVAGED-SECONDARY
C   VLSALR:   COUNTER FOR VOLUME SALVAGED-PRODUCT

```

## C STORAGE ALLOCATION

```

INTEGER *2 IDF(1:LIM),AGE(1:LIM),YCPR(1:LIM),YCFU(1:LIM)
INTEGER *2 YCPL(1:LIM),PLP(1:LIM),MAN(1:LIM),OWN
INTEGER *2 NCLASS,FC,TIME,RTIME,NCL,J
INTEGER *4 AREAF(1:LIM)
INTEGER *4 START,BAREA,AREA,MONTE,TAREA,FLAM,R
INTEGER *4 FCB,BRNA,NFC
REAL ALOCAT(1:LIM),OVOLP(1:LIM),OVOLS(1:LIM),PVOL(1:LIM),RISK
REAL BRNP,BRNS,BRNPR,VLP,VLS,VLPR
REAL VLBRNP,VLBRNS,PVLBRN,VLSALP,VLSALS,VLSALR
EXTERNAL AREA,MONTE,FLAM

```

## C DECLARE COMMON VARIABLES

```

COMMON /VLBRN/VLBRNP,VLBRNS,PVLBRN
COMMON /SAL/VLSALP,VLSALS,VLSALR

```

## C INITIALIZE VARIABLES

```

BRNA=0
BRNP=0.0
BRNS=0.0
BRNPR=0
VLP=0.0
VLS=0.0
VLPR=0.0

RTIME=TIME*5
WRITE(9,1002)RTIME

```

## C DETERMINE BURN CHARACTERISTICS OF EACH START

```

DO 1 I=1,START

```

## C DETERMINE BURN AREA FOR EACH START

```

BAREA=AREA()
IF (BAREA .GT. TAREA) THEN
PRINT *, 'THE WHOLE FOREST WAS BURNED, GO HOME!'
RETURN
ENDIF

```

```

100 CONTINUE

```

## C ASSIGN START TO FOREST CLASS AND READ FLAMMABILITY

```

FC=MONTE(NFC,ALOCAT,IDF)
R= FLAM(FC,YCPR)
RISK=REAL(R)

```

```

C      COMPARE AREA IN BURN TO AREA IN FOREST CLASS
      IF (AREAF(FC) .GE. BAREA) THEN
          NCLASS=NCLASS+1
          NCL=NCL+1
          IDF(NCLASS)=NCL
          AREAF(NCLASS)=BAREA
          AGE(NCLASS)=0
          YCPR(NCLASS)=YCFU(FC)
          YCFU(NCLASS)=YCFU(FC)
          YCPL(NCLASS)=YCPL(FC)
          OWN=OWN
          PLP(NCLASS)=PLP(FC)
          MAN(NCLASS)=MAN(FC)
          FCB=BAREA
C      DETERMINE VOLUME LOSS OF BURN
          CALL LOSS(I,RISK,BAREA,FC,FCB,AGE,AREAF,OVOLP,OVOLS,PVOL)
          AREAF(FC)=AREAF(FC)-BAREA
          BAREA=0
      ELSEIF (AREAF(FC) .LE. 0) THEN
          GO TO 100
      ELSEIF (AREAF(FC) .LT. BAREA) THEN
          NCLASS= NCLASS+1
          NCL=NCL+1
          IDF(NCLASS)=NCL
          AREAF(NCLASS)=AREAF(FC)
          AGE(NCLASS)=0
          YCPR(NCLASS)=YCFU(FC)
          YCFU(NCLASS)=YCFU(FC)
          YCPL(NCLASS)=YCPL(FC)
          OWN=OWN
          PLP(NCLASS)=PLP(FC)
          MAN(NCLASS)=MAN(FC)
          FCB=AREAF(FC)
C      DETERMINE VOLUME LOSS OF BURN
          CALL LOSS(I,RISK,BAREA,FC,FCB,AGE,AREAF,OVOLP,OVOLS,PVOL)
          BAREA=BAREA-AREAF(FC)
          AREAF(FC)=0
      ENDIF
C      CALCULATE TOTALS FOR THE ITERATION
          BRNA=BRNA+FCB
          BRNP=BRNP+VLBRNP
          BRNS=BRNS+VLBRNS
          BRNPR=BRNPR+PVLBRN
          VLP=VLP+VLSALP
          VLS=VLS+VLSALS
          VLPR=VLPR+VLSALR
          IF(BAREA .GT. 0) THEN
              GO TO 100
          ENDIF

```

CONTINUE

```
WRITE(9,1003) BRNA,BRNP,BRNS,BRNPR,VLP,VLS,VLPR
1002 FORMAT('RECORD OF BURN FOR YEAR ', I3//'START',2X,
* 'FOREST',1X,'NEW',9X,'AREA',7X,'PRIMARY',6X,'SECONDARY',
* 3X,'PRODUCT',8X,'SALVAGE',4X,'SALVAGE',4X,'SALVAGE' /
* 'NUMBER',1X,'CLASS',2X,'AGE',19X,'VOL BURNED',
* 3X,'VOL BURNED',1X,'VOL BURNED', 9X,'VOL',8X,'VOL',8X,
* 'VOL',/76X,'CAPTURED',3X,'CAPTURED',3X,'CAPTURED' /
* 76X,'PRIMARY',3X,'SECONDARY',4X,'PRODUCT'//)
1003 FORMAT(/,'TOTAL',20X,I6,2X,F11.2,3X,F11.2,F11.2,3X,F11.2,
* 1X,F11.2,F11.2//)
RETURN
END
```



APPENDIX A-9  
Subprogram FLAM.FOR

```

C                               SUBPROGRAM FLAM.FOR
C
C   FLAM ASSIGNS A FLAMMABILITY FACTOR TO FOREST
C   CLASSES ACCORDING TO PRESENT CURVE VALUE
C
C   INTEGER FUNCTION FLAM(I,IYCPR)
C
C   VARIABLES
C
C   IYCPR(I):  PRESENT CURVE SET
C   I:         COUNTER
C   X:         TEMPORARY STORAGE FOR FLAMMABILITY
C
C   PARAMETER(LIM=800)
C
C   STORAGE ALLOCATION
C
C   INTEGER*2 IYCPR(1:LIM)
C   INTEGER*2 I
C   INTEGER*4 LIM,X
C
C   ASSIGN FLAMMABILITY BASED ON PRESENT CURVE SET (SPECIES)
C
C   IF (IYCPR(I) .EQ. 15) X=0
C
C   IF ((IYCPR(I) .EQ. 1) .OR. (IYCPR(I) .EQ. 8) .OR.
C   (IYCPR(I) .EQ. 3)) THEN
C   X=10
C
C   ELSEIF ((IYCPR(I) .EQ. 2) .OR. (IYCPR(I) .EQ. 4) .OR.
C   (IYCPR(I) .EQ. 13)) THEN
C   X=3
C
C   ELSEIF ((IYCPR(I) .EQ. 5) .OR. (IYCPR(I) .EQ. 6) .OR.
C   (IYCPR(I) .EQ. 10) .OR. (IYCPR(I) .EQ. 11) .OR.
C   (IYCPR(I) .EQ. 14)) THEN
C   X=4
C
C   ELSEIF((IYCPR(I) .EQ. 7) .OR. (IYCPR(I) .EQ. 9) .OR.
C   (IYCPR(I) .EQ. 12)) THEN
C   X=8
C
C   ENDIF
C
C   FLAM=X
C
C   RETURN
C   END

```

APPENDIX A-10  
Subprogram LOSS.FOR

```

C                               SUBPROGRAM LOSS.FOR
C
C   LOSS DETERMINES THE VOLUME LOSS AND SALVAGE POTENTIAL
C   FOR EACH FOREST CLASS BURNED
C
C   SUBROUTINE LOSS(ST,FLAM,BAREA,I,FCBA,AGE,AREAF,OVOLP,OVOLS,PVOL)
C
C   VARIABLES
C
C   ST:           START NUMBER
C   FLAM:        FLAMMABILITY ASSOCIATED WITH FOREST CLASS BURNED
C   BAREA:       BURN AREA
C   I:           FOREST CLASS ID
C   FCBA:        BURN AREA IN FOREST CLASS
C   AGE:         AGE OF FOREST CLASS
C   AREAF(I):    AREA IN FOREST CLASS
C   NAGE:        AGE ADJUSTMENT FOR ENDEMIC FIRES
C   OVOLP(I):    OPERABLE VOLUME-PRIMARY
C   OVOLS(I):    OPERABLE VOLUME-SECONDARY
C   PVOL(I):     PRODUCT VOLUME
C   REDUCE:      FIRE INTENSITY
C   PROP:        AREA IN FOREST CLASS/FOREST AREA
C   RB:          REAL VALUE OF FCBA
C   RA:          REAL VALUE OF AREAF
C   RAGE:        REAL VALUE OF AGE IN YEARS
C   VLBRNP:      VOLUME BURNED-PRIMARY IN AN ITERATION
C   VLBRNS:      VOLUME BURNED-SECONDARY IN AN ITERATION
C   PVLBRN:      VOLUME BURNED-PRODUCT IN AN ITERATION
C   LOSSP:       VOLUME LOSS-PRIMARY IN AN ITERATION
C   LOSSS:       VOLUME LOSS-SECONDARY IN AN ITERATION
C   LOSSR:       VOLUME LOSS-PRODUCT IN AN ITERATION
C   VLSALP:      VOLUME SALVAGED-PRIMARY IN AN ITERATION
C   VLSALS:      VOLUME SALVAGED-SECONDARY IN AN ITERATION
C   VLSALR:      VOLUME SALVAGED-PRODUCT IN AN ITERATION
C
C   PARAMETER (LIM=800)
C
C   STORAGE ALLOCATION
C
C   INTEGER*2 AGE(1:LIM),NAGE
C   INTEGER*2 I
C   INTEGER*4 AREAF(1:LIM),BAREA,ST,FCBA
C   REAL REDUCE,OVOLP(1:LIM),OVOLS(1:LIM),PVOL(1:LIM),PROP,RB,RA
C   REAL VLBRNP,VLBRNS,LOSSP,LOSSS,VLSALP,VLSALS,PVLBRN,LOSSR,VLSALR
C   REAL RAGE,FLAM
C
C   DECLARE COMMON VARIABLES
C
C   COMMON /VLBRN/VLBRNP,VLBRNS,PVLBRN
C   COMMON /SAL/VLSALP,VLSALS,VLSALR
C
C   DETERMINE THE AGE IN YEARS
C
C   RAGE=REAL(AGE(I)*5)
C
C   DETERMINE THE FIRE INTENSITY, AS A FUNCTION OF AGE AND
C   FLAMMABILITY FACTOR
C
C   REDUCE=(RAGE/1000)*FLAM

```

```

C   CONVERT INTEGER VALUES TO REAL VALUES
    RB=REAL(FCBA)
    RA=REAL(AREAF(I))

C   IF FIRE INTENSITY IS GREATER THAN 75% THEN NO SALVAGE IS
C   POSSIBLE

    IF (REDUCE .GE. .75) THEN
      REDUCE =1
      IF (AREAF(I) .LT. BAREA) THEN
        PROP=1.00
      ELSE
        PROP=RB/RA
      ENDIF

C   IF FIRE INTENSITY IS LESS THAN 20% THE AGE OF THE FOREST CLASS
C   IS REDUCED

      ELSEIF (REDUCE .LT. .20) THEN
        PROP=0
        REDUCE=0
        AGE(I)=AGE(I) - 1
        IF (AGE(I) .LE. 0) AGE(I)=0

C   IF FIRE INTENSITY IS >20% AND <75% THEN SALVAGE IS POSSIBLE

      ELSE
        IF (AREAF(I) .LT. BAREA) THEN
          PROP=1
        ELSE
          PROP=RB/RA
        ENDIF
      ENDIF

C   DETERMINE VOLUME BURNED AS A PROPORTION OF THE TOTAL VOLUME IN
C   THE FOREST CLASS

      VLBRNP =PROP*OVOLP(I)
      VLBRNS =PROP*OVOLS(I)
      PVLBRN =PROP*PVOL(I)

C   DETERMINE THE VOLUME LOSS BY FIRE INTENSITY

      LOSSP = VLBRNP *REDUCE
      LOSSS = VLBRNS *REDUCE
      LOSSR = PVLBRN *REDUCE

C   DETERMINE SALVAGE VOLUMES AS THE DIFFERENCE BETWEEN VOLUME
C   BURNED AND VOLUME LOST

      VLSALP = VLBRNP - LOSSP
      VLSALS = VLBRNS - LOSSS
      VLSALR = PVLBRN - LOSSR

C   REDUCE THE OPERABLE VOLUME FOR THE FOREST CLASS ACCORDING TO
C   VOLUME LOST

      OVOLP(I) = OVOLP(I) - VLBRNP
      OVOLS(I) = OVOLS(I) - VLBRNS
      PVOL(I) = PVOL(I) - PVLBRN

```

```
NAGE=AGE(I)*5
* WRITE (9,1001) ST,I,NAGE,FCBA,VLBRNP,VLBRNS,PVLBRN,
VLSALP,VLSALS,VLSALR
1001 FORMAT(I3,4X,I3,4X,I3,10X,I4,2X,F11.2,3X,F11.2,F11.2,
* 3X,F11.2,1X,F11.2,F11.2)
RETURN
END
```

APPENDIX B

APPENDIX B-1

Age class distribution of white birch on the Nakina Forest



Area (hectares)

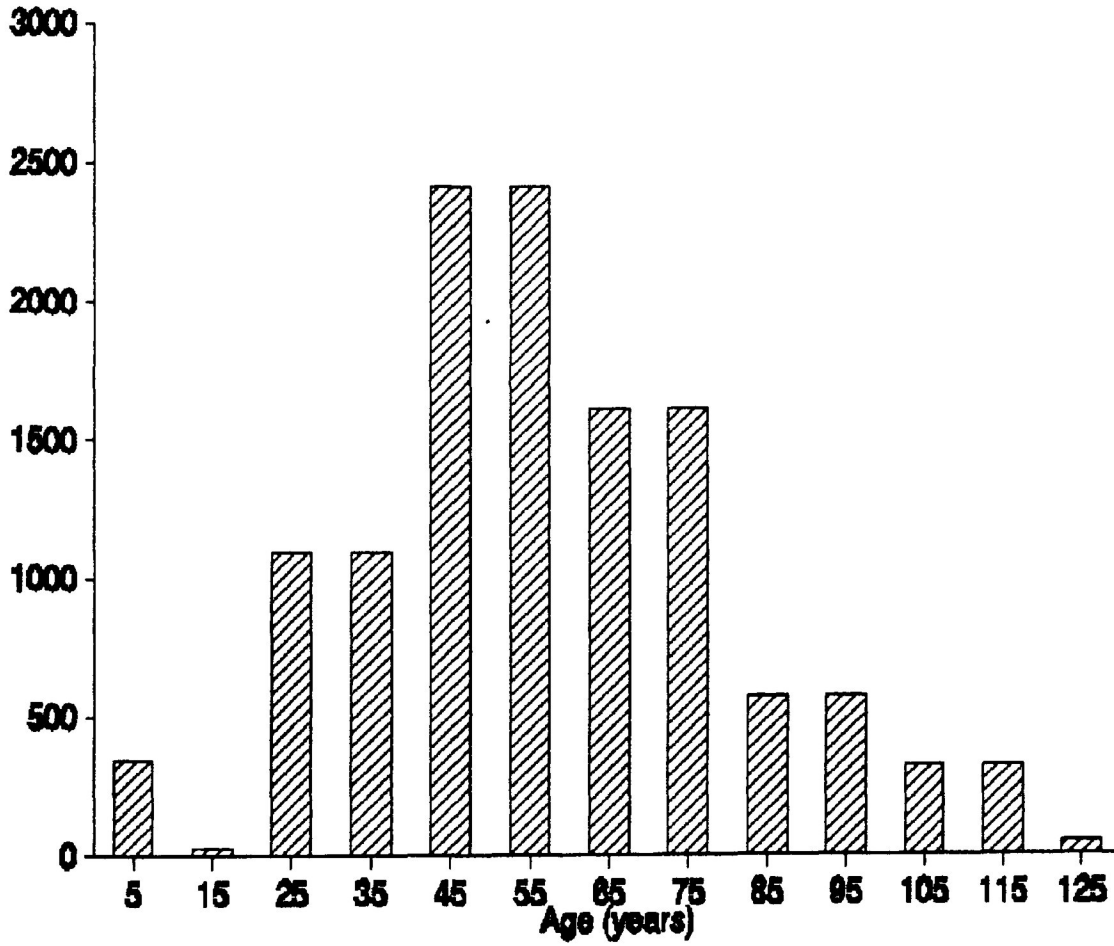

Age Class distribution - white birch

APPENDIX B-2

Age class distribution of poplar on the Nakina Forest

Area (hectares)

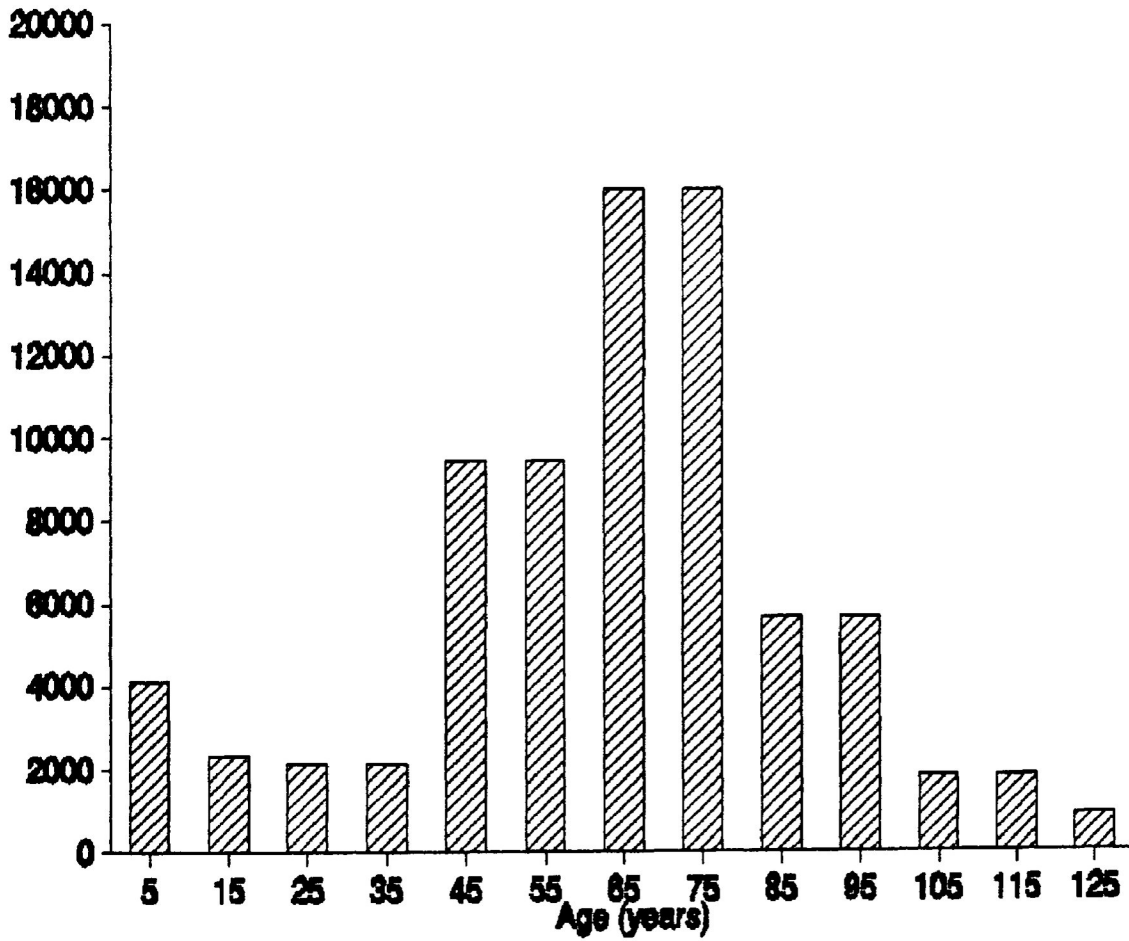

Age Class distribution - poplar

APPENDIX B-3

Age class distribution of jack pine on the Nakina Forest

Area (hectares)

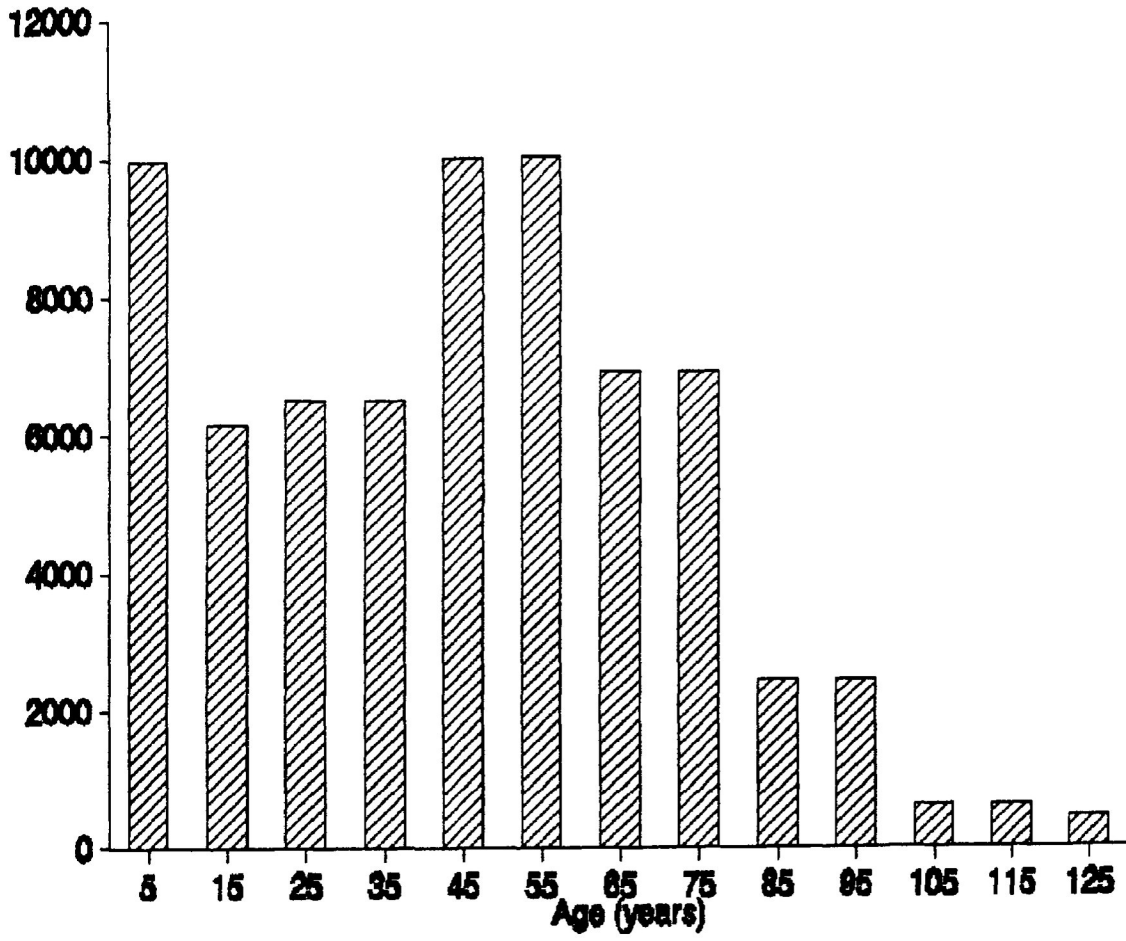

Age Class distribution - jack pine

APPENDIX B-4

Age class distribution of balsam fir on the Nakina Forest

Area (hectares)

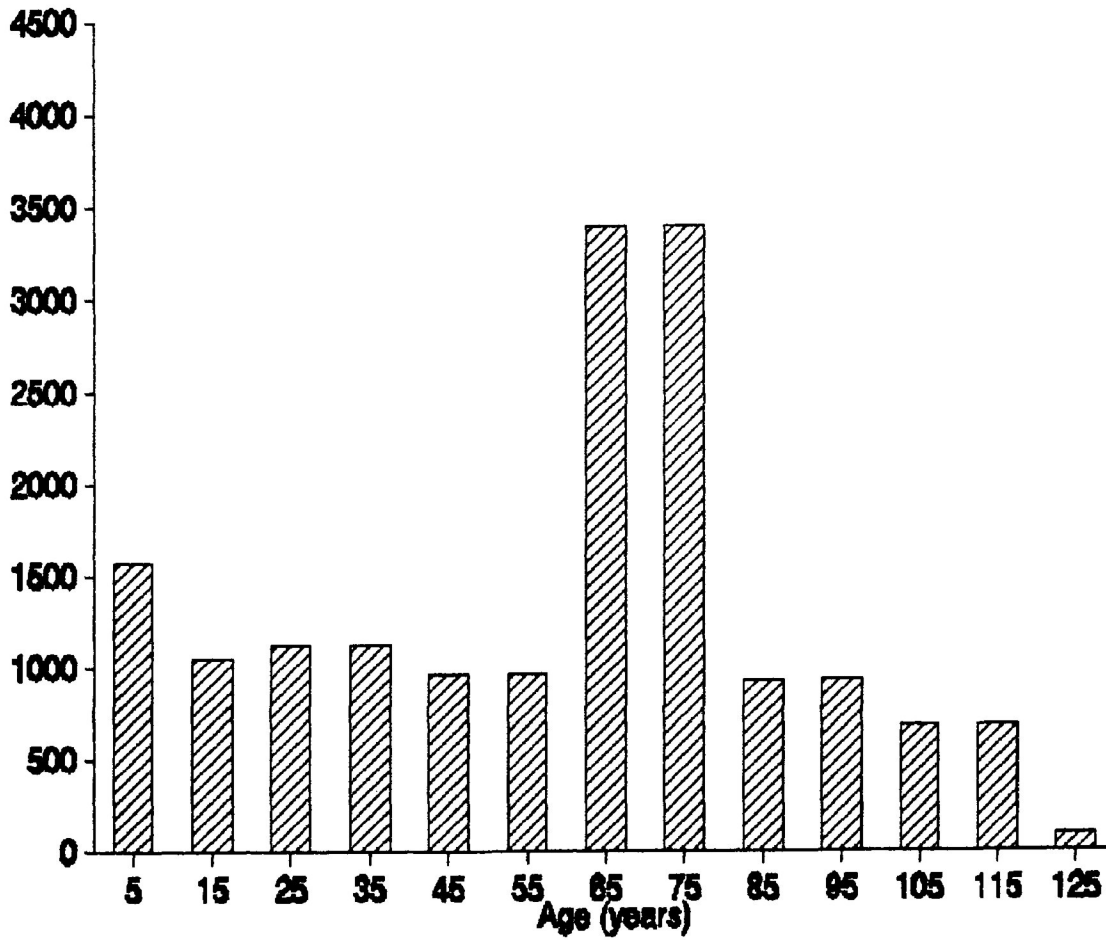

Age Class distribution - balsam fir

APPENDIX B-5

Age class distribution of spruce  
site class X,1,2 (upland) on the Nakina Forest

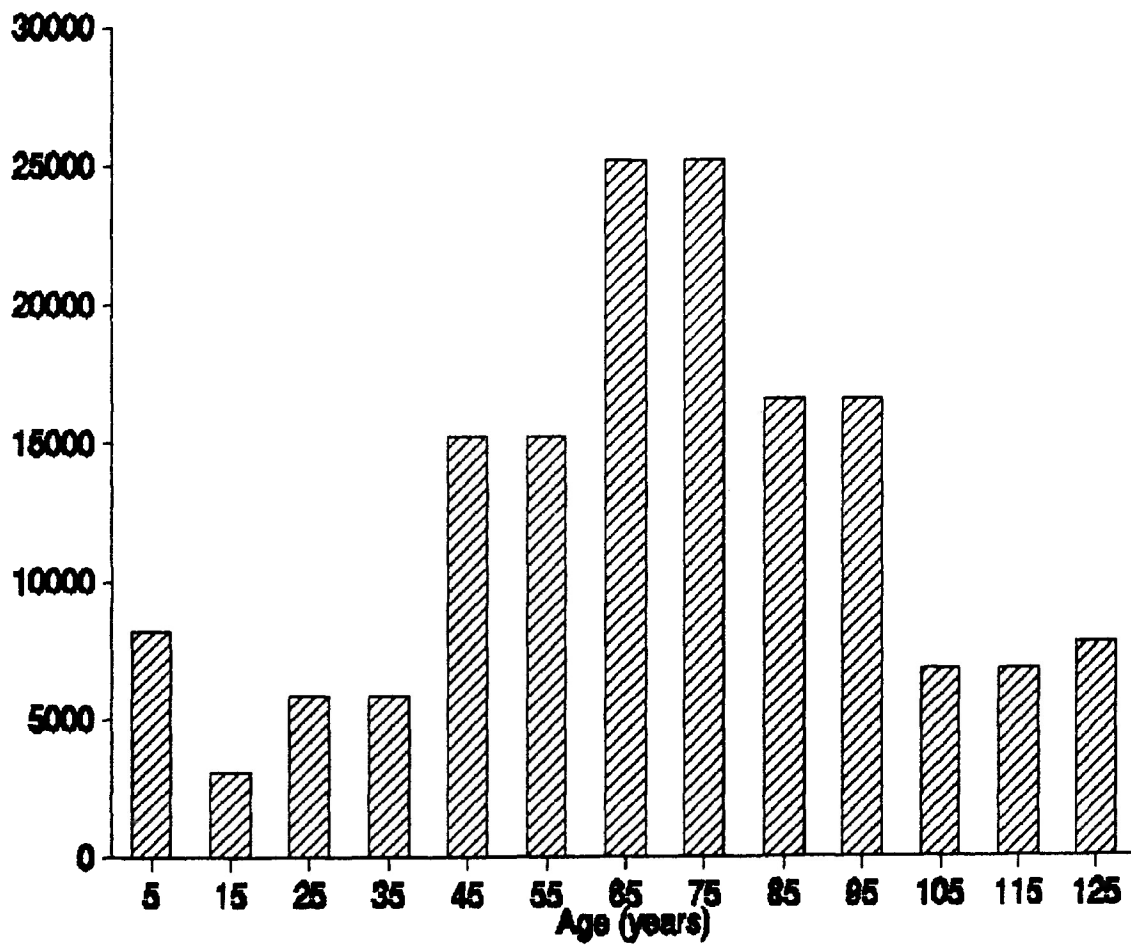

Area (hectares)

**Age Class distribution - spruce: site class X,1,2 (Upland)**

APPENDIX B-6

Age class distribution of spruce  
site class X,1,2 (lowland) on the Nakina Forest

Area (hectares)

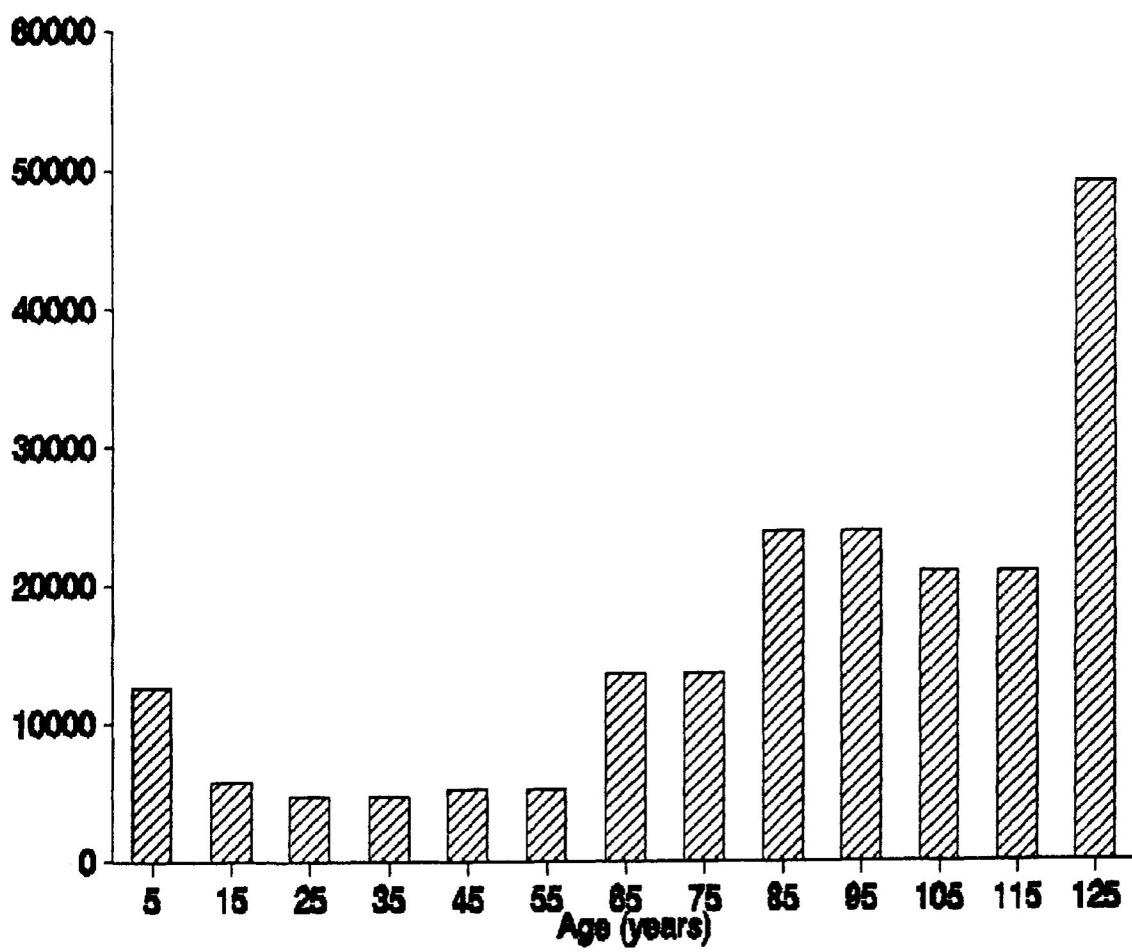

Age Class distribution - spruce: site class X,1,2 (Lowland)

APPENDIX B-7

Age class distribution of spruce  
site class 3, PFR on the Nakina Forest

Area (hectares)

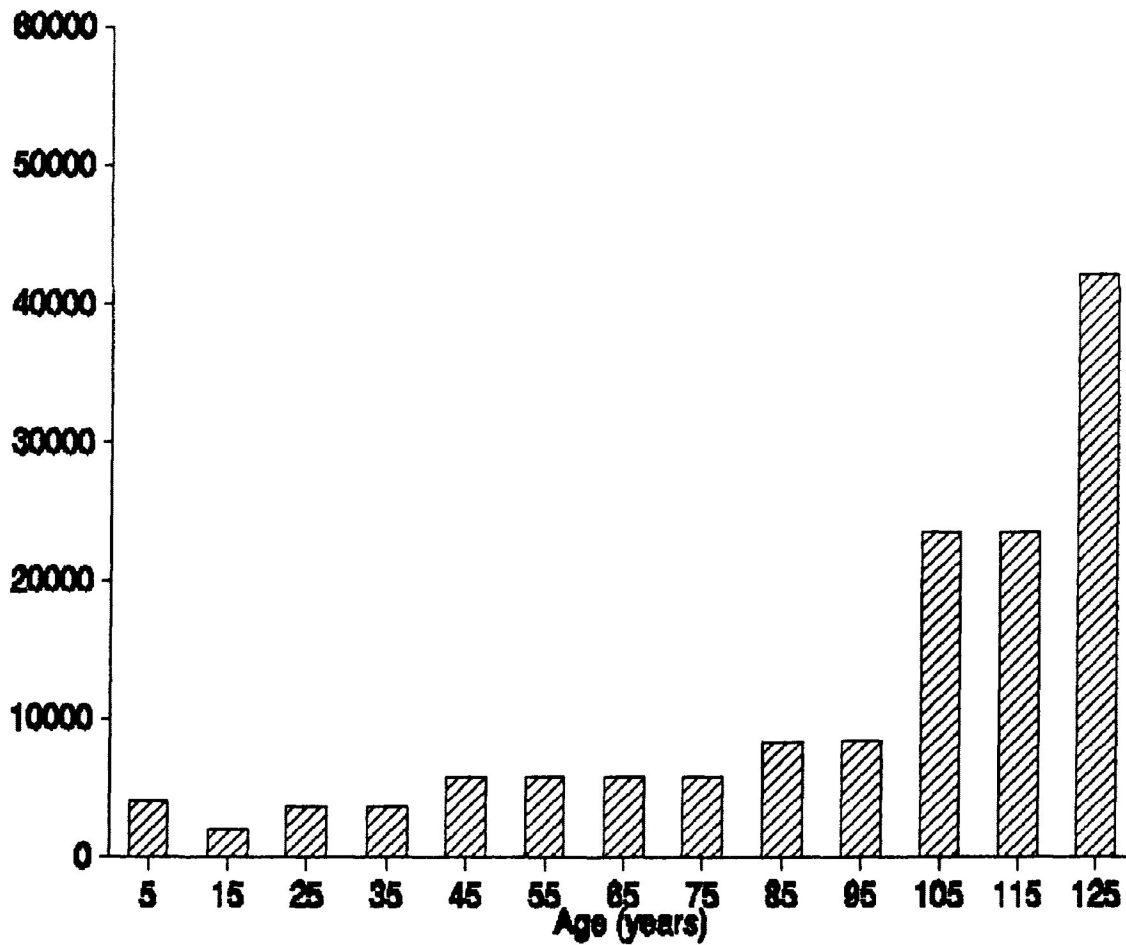

Age Class distribution - spruce: site class 3, PFR

APPENDIX B-8

Forest class file (grostk.nak) for the Nakina Forest

20	83						
1	1490	5	1	1	9	6100	3
2	1004	15	1	1	9	6100	3
3	1070	25	1	1	9	6100	3
4	1070	35	1	1	9	6100	3
5	916	45	1	1	9	6100	3
6	919	55	1	1	9	6100	3
7	3227	65	1	1	9	6100	3
8	3227	75	1	1	9	6100	3
9	885	85	1	1	9	6100	3
10	887	95	1	1	9	6100	3
11	650105		1	1	9	6100	3
12	651115		1	1	9	6100	3
13	92125		1	1	9	6100	3
14	78	5	1	15	15	0100	3
15	53	15	1	15	15	0100	3
16	56	25	1	15	15	0100	3
17	56	35	1	15	15	0100	3
18	48	45	1	15	15	0100	3
19	48	55	1	15	15	0100	3
20	170	65	1	15	15	0100	3
21	170	75	1	15	15	0100	3
22	47	85	1	15	15	0100	3
23	47	95	1	15	15	0100	3
24	34105		1	15	15	0100	3
25	35115		1	15	15	0100	3
26	5125		1	15	15	0100	3
27	330	5	2	13	9	5100	3
28	28	15	2	13	9	5100	3
29	1038	25	2	13	9	5100	3
30	1038	35	2	13	9	5100	3
31	2292	45	2	13	9	5100	3
32	2294	55	2	13	9	5100	3
33	1530	65	2	13	9	5100	3
34	1531	75	2	13	9	5100	3
35	544	85	2	13	9	5100	3
36	546	95	2	13	9	5100	3
37	306105		2	13	9	5100	3
38	307115		2	13	9	5100	3
39	44125		2	13	9	5100	3
40	17	5	2	15	15	0100	3
41	1	15	2	15	15	0100	3
42	54	25	2	15	15	0100	3
43	54	35	2	15	15	0100	3
44	120	45	2	15	15	0100	3
45	121	55	2	15	15	0100	3
46	81	65	2	15	15	0100	3
47	81	75	2	15	15	0100	3
48	28	85	2	15	15	0100	3
49	28	95	2	15	15	0100	3
50	16105		2	15	15	0100	3
51	16115		2	15	15	0100	3
52	3125		2	15	15	0100	3
53	9487	5	3	3	8	3100	3
54	5877	15	3	3	8	3100	3
55	6206	25	3	3	8	3100	3
56	6207	35	3	3	8	3100	3
57	9544	45	3	3	8	3100	3
58	9567	55	3	3	8	3100	3
59	6618	65	3	3	8	3100	3
60	6621	75	3	3	8	3100	3

61	2344	85	3	3	8	3100	3
62	2347	95	3	3	8	3100	3
63	593105		3	3	8	3100	3
64	593115		3	3	8	3100	3
65	435125		3	3	8	3100	3
66	500	5	3	15	15	0100	3
67	309	15	3	15	15	0100	3
68	327	25	3	15	15	0100	3
69	327	35	3	15	15	0100	3
70	502	45	3	15	15	0100	3
71	502	55	3	15	15	0100	3
72	348	65	3	15	15	0100	3
73	348	75	3	15	15	0100	3
74	123	85	3	15	15	0100	3
75	123	95	3	15	15	0100	3
76	31105		3	15	15	0100	3
77	32115		3	15	15	0100	3
78	24125		3	15	15	0100	3
79	3904	5	4	4	9	1100	3
80	2222	15	4	4	9	1100	3
81	2021	25	4	4	9	1100	3
82	2021	35	4	4	9	1100	3
83	8999	45	4	4	9	1100	3
84	9000	55	4	4	9	1100	3
85	15210	65	4	4	9	1100	3
86	15214	75	4	4	9	1100	3
87	5382	85	4	4	9	1100	3
88	5385	95	4	4	9	1100	3
89	1730105		4	4	9	1100	3
90	1733115		4	4	9	1100	3
91	881125		4	4	9	1100	3
92	205	5	4	15	15	0100	3
93	117	15	4	15	15	0100	3
94	107	25	4	15	15	0100	3
95	107	35	4	15	15	0100	3
96	474	45	4	15	15	0100	3
97	474	55	4	15	15	0100	3
98	801	65	4	15	15	0100	3
99	801	75	4	15	15	0100	3
100	282	85	4	15	15	0100	3
101	282	95	4	15	15	0100	3
102	91105		4	15	15	0100	3
103	91115		4	15	15	0100	3
104	47125		4	15	15	0100	3
105	12024	5	5	11	10	2100	3
106	5548	15	5	11	10	2100	3
107	4571	25	5	11	10	2100	3
108	4572	35	5	11	10	2100	3
109	4937	45	5	11	10	2100	3
110	4940	55	5	11	10	2100	3
111	13015	65	5	11	10	2100	3
112	13016	75	5	11	10	2100	3
113	22733	85	5	11	10	2100	3
114	22734	95	5	11	10	2100	3
115	19853105		5	11	10	2100	3
116	19854115		5	11	10	2100	3
117	46606125		5	11	10	2100	3
118	633	5	5	15	15	0100	3
119	292	15	5	15	15	0100	3
120	240	25	5	15	15	0100	3
121	240	35	5	15	15	0100	3



122	260	45	5	15	15	0100	3
123	260	55	5	15	15	0100	3
124	685	65	5	15	15	0100	3
125	686	75	5	15	15	0100	3
126	1196	85	5	15	15	0100	3
127	1196	95	5	15	15	0100	3
128	10461	105	5	15	15	0100	3
129	10461	115	5	15	15	0100	3
130	24531	125	5	15	15	0100	3
131	3846	5	6	14	14	0100	3
132	1968	15	6	14	14	0100	3
133	3466	25	6	14	14	0100	3
134	3469	35	6	14	14	0100	3
135	5574	45	6	14	14	0100	3
136	5575	55	6	14	14	0100	3
137	5585	65	6	14	14	0100	3
138	5586	75	6	14	14	0100	3
139	7894	85	6	14	14	0100	3
140	7989	95	6	14	14	0100	3
141	223881	105	6	14	14	0100	3
142	223911	115	6	14	14	0100	3
143	401081	125	6	14	14	0100	3
144	202	5	6	15	15	0100	3
145	104	15	6	15	15	0100	3
146	182	25	6	15	15	0100	3
147	182	35	6	15	15	0100	3
148	293	45	6	15	15	0100	3
149	293	55	6	15	15	0100	3
150	294	65	6	15	15	0100	3
151	294	75	6	15	15	0100	3
152	415	85	6	15	15	0100	3
153	415	95	6	15	15	0100	3
154	11781	105	6	15	15	0100	3
155	11781	115	6	15	15	0100	3
156	21121	125	6	15	15	0100	3
157	7787	5	7	12	9	6100	3
158	2668	15	7	12	9	6100	3
159	5522	25	7	12	9	6100	3
160	5523	35	7	12	9	6100	3
161	14439	45	7	12	9	6100	3
162	14441	55	7	12	9	6100	3
163	23949	65	7	12	9	6100	3
164	23952	75	7	12	9	6100	3
165	15781	85	7	12	9	6100	3
166	15783	95	7	12	9	6100	3
167	64271	105	7	12	9	6100	3
168	64291	115	7	12	9	6100	3
169	74301	125	7	12	9	6100	3
170	410	5	7	15	15	0100	3
171	410	15	7	15	15	0100	3
172	291	25	7	15	15	0100	3
173	291	35	7	15	15	0100	3
174	761	45	7	15	15	0100	3
175	761	55	7	15	15	0100	3
176	1260	65	7	15	15	0100	3
177	1260	75	7	15	15	0100	3
178	830	85	7	15	15	0100	3
179	830	95	7	15	15	0100	3
180	3471	105	7	15	15	0100	3
181	3481	115	7	15	15	0100	3
182	3921	125	7	15	15	0100	3

APPENDIX B-9

Curve set file (yield.viv) for the Nakina Forest





APPENDIX B-10

Treatment cost file (Silvcost) for the Nakina Forest

1	1	86
1	9	1021
2	13	86
2	9	1021
3	3	432
3	8	1021
4	4	130
4	9	1021
5	10	979
5	11	464
6	14	443
7	9	1021
7	12	173
8	8	1021
9	9	1021
10	10	979
11	11	464
12	12	173
13	13	86
14	14	443
11	10	1021
12	9	1021
13	9	1021

APPENDIX B-11

FORMAN short report for the Nakina Forest

FORMAN VERSION 2.1

BACKGROUND HARVEST

HARVEST LEVEL (M3/ITERATION):

2600000 2600000 2600000 2600000 2600000 2600000 2600000 2600000 2600000 2600000  
 2600000 2600000 2600000 2600000 2600000 2600000 2600000 2600000 2600000 2600000

PLANTING LEVEL (HA/ITERATION):

5000 5000 5000 5000 5000 5000 5000 5000 5000 5000  
 5000 5000 5000 5000 5000 5000 5000 5000 5000 5000

SPACING LEVEL (HA/ITERATION):

0 0 0 0 0 0 0 0 0 0  
 0 0 0 0 0 0 0 0 0 0

HARVEST RULES

%	RULE1	%	RULE2	TIME RANGE
75	1 2 0	25	3 2 1	0 - 100

OWNERSHIP: CROWN

CURVE SET FILE: yield.viv  
 FOREST CLASS FILE: nak.man  
 COST FILE: silvcost

REPORT ON THE FOREST

135

RESIDUAL FOREST				STATISTICS FOR THE PERIOD											
TIME	OPERABLE VOLUME (M3)			VOLUME CUT (M3)			AREA (HA)			COSTS (\$1000)			MORTALITY (M3)		
	PRIMARY	SECONDARY	PRODUCT	PRIMARY	SECONDARY	PRODUCT	CUT	PLANT	SPACE	HARVEST	PLANT	MAINT.	SPACE	POT.	REAL.
5	20703250.	8296753.	0.	2599997	27281	0	29943	5000	0	0	4916	11561	0	42740.	12262.
10	20905390.	8569213.	0.	2599997	460545	0	27788	5000	0	0	5104	7683	0	2876.	0.
15	21200320.	8958584.	0.	2599997	277818	0	30417	5000	0	0	5105	9858	0	7535.	0.
20	20755440.	9353130.	0.	2599997	239829	0	33762	5000	0	0	4968	11591	0	2855.	0.
25	20217550.	9724617.	0.	2599997	203153	0	36633	5000	0	0	5105	12958	0	24383.	0.
30	19549280.	9740887.	0.	2599997	545612	0	28161	5000	0	0	5105	7549	0	4331.	0.
35	18810120.	9918356.	0.	2599997	299366	0	35659	5000	0	0	5105	12017	0	21188.	0.
40	17458940.	9494328.	0.	2599997	892169	0	30298	5000	0	0	5105	8076	0	7523.	0.
45	15998590.	9593843.	0.	2599997	317454	0	35292	5000	0	0	5105	11397	0	20012.	0.
50	14543940.	8983211.	0.	2599997	1001719	0	27391	5000	0	0	5105	7070	0	5543.	0.
55	13067820.	8922238.	0.	2599997	428819	0	30441	5000	0	0	5105	7831	0	7882.	0.
60	12141970.	7282409.	0.	2599997	1983206	0	34453	5000	0	0	5105	8276	0	14093.	0.
65	10815500.	7105454.	0.	2599997	540175	0	29368	5000	0	0	5105	6094	0	907.	0.
70	9154826.	5545322.	0.	2599997	1932347	0	34819	5000	0	0	5105	8418	0	13358.	0.
75	7982291.	3900866.	0.	2599997	2028768	0	34518	5000	0	0	5105	5371	0	24.	0.
80	6351262.	3228912.	0.	2599997	1041512	0	27943	5000	0	0	5105	5920	0	0.	0.
85	5174005.	3004675.	0.	2599997	704038	0	27657	5000	0	0	5105	5629	0	288.	0.
90	4498693.	2236189.	0.	2599997	1228938	0	28886	5000	0	0	5105	5919	0	0.	0.
95	2613186.	2401681.	0.	2599997	372863	0	28977	5000	0	0	4917	6965	0	0.	0.
100	2628158.	1977387.	0.	2599997	1056353	0	30980	5000	0	0	5105	7585	0	0.	0.



AGE CLASS STRUCTURE (HA)

TIME	AGE CLASS									
	0-20	20-40	40-60	60-80	80-100	100-120	120-140	140-160	160-180	180-200
5	51053	41755	81634	120814	97173	90797	83524	0	0	0
10	63900	37971	61682	101234	108954	93756	99253	0	0	0
15	91688	37971	61682	101234	108954	92981	72240	0	0	0
20	88148	51053	41755	81634	119476	95447	43234	46003	0	0
25	91967	80996	41755	81634	119476	87202	40635	23085	0	0
30	100812	91688	37971	61682	99897	106367	48731	19602	0	0
35	98556	122105	37971	61682	99897	96077	31239	19223	0	0
40	100453	121910	51053	41755	79630	115320	37030	19560	39	0
45	94118	128600	80996	41755	79630	105030	18572	18010	39	0
50	101249	128973	91688	37971	59680	91508	48667	6975	39	0
55	92981	134215	122105	37971	59680	83234	29589	6975	0	0
60	93124	130751	121910	51053	40848	69540	52628	6896	0	0
65	92285	129410	128600	80996	40848	67395	27216	0	0	0
70	94262	128640	128973	91688	37064	48800	37323	0	0	0
75	98640	123422	134215	121684	37064	43862	7863	0	0	0
80	98705	127577	130751	117482	51029	30086	11120	0	0	0
85	97280	121653	129410	116671	80463	21273	0	0	0	0
90	90118	129081	128640	112207	86744	19960	0	0	0	0
95	88486	133158	123422	117449	96160	8075	0	0	0	0
100	89520	126648	127577	112415	93567	17023	0	0	0	0